

# Pony Club



## Gymkhana Rulebook

2024

---

## THE USPC PLEDGE

*As a Member of the United States Pony Club, I stand for the best in sportsmanship as well as in horsemanship. I shall compete for the enjoyment of the game well played and take winning or losing in stride, remembering that without good manners and good temper, sport loses its cause for being. I shall endeavor to maintain the best tradition of the ancient and noble skill of horsemanship, always treating my mount with consideration due a partner.*

## USPC MISSION STATEMENT

The United States Pony Clubs, Inc. is an educational organization which builds the foundations of teamwork and sportsmanship through riding, mounted sports, care of horses and ponies, while developing and enhancing leadership, confidence, responsibility, and a sense of community in its youth and adult members.

### Introduction

Gymkhana offers all riders the opportunity to compete in timed races in divisions suited to their abilities and under a uniform set of rules. The variety of races offers the enjoyment of horsemanship and sportsmanship that Gymkhana can provide.

The goal of the mount and rider combination is to complete the race according to the established pattern and requirements without errors. Each race is designed to allow the rider/mount team to demonstrate their skill and partnership in a variety of skills and include demonstrating control, variations of speed, turning and navigating obstacles, hand eye coordination, and safely completing the race.

### Competitions

A Gymkhana rally will generally offer a variety of different races; from as few as four to as many as twelve per day. The competitions may be held in nearly any type of venue, although soil or sand footing is recommended as well as some type of perimeter fencing. There is a timer which records the time taken by each competitor in each race. Each race is run with one rider in the

## USPC CORE VALUES

**H**orsemanship with respect to healthcare, nutrition, stable management, handling and riding a mount safely, correctly and with confidence.

**O**rganized teamwork including cooperation, communication, responsibility, leadership, mentoring, teaching and fostering a supportive yet competitive environment.

**R**espect for the mount and self through horsemanship; for land through land conservation; and for others through service and teamwork.

**S**ervice by providing an opportunity for members, parents, and others to support the Pony Club program locally, regionally and nationally through volunteerism.

**E**ducation at an individual pace to achieve personal goals and expand knowledge through teaching others.

ring at a time. Most of the races are completed with poles and/or barrels, although there are some race options with a few other types of equipment. At the highest levels, it is expected competitors will run these events at speed. Good horsemanship and safety are always a priority and there are divisions even for the beginning rider.

### Gymkhana in Pony Club

Members compete on a team of three to four riders and an unmounted stable manager. As with all disciplines, good Horse Management is an integral to Gymkhana. Members who are eligible and meet the requirements of the discipline at their regional rally may go on to compete in Championships.

© 2024 The United States Pony Clubs, Inc. (USPC)

4041 Iron Works Parkway, Lexington, Kentucky 40511-8462 • (859) 254-7669 • Fax (859) 233-4652  
Copying permitted for internal use only by members and volunteers of The United States Pony Clubs

# Table of Contents

## SECTION I: USPC Uniform

### Officiation Rules

Article 1—Rally Definition .....	1
Article 2—Governing Rules .....	1
Article 3—Responsibility .....	1
Article 4—Legal Liability .....	1
Article 5—Member Participation and Eligibility .....	2
Article 6—Member in Good Standing .....	2
Article 7—Code of Conduct Expectations .....	2
Article 8—Substances and Weapons .....	2
Article 9—Mounts .....	3
Article 10—Substitution of Mounts .....	3
Article 11—Sharing of Mounts .....	3
Article 12—Veterinary Care and Medications .....	3
Article 13—Cruelty to and Abuse of a Mount .....	3
Article 14—Dangerous Riding .....	4
Article 15—Safety .....	4
Article 16—Heat Related Information .....	5
Article 17—Concussion and Return to Play .....	6
Article 18—Unauthorized and Permitted Assistance .....	6
Article 19—Excused .....	6
Article 20—Elimination .....	7
Article 21—Disqualification .....	7

## SECTION II: General Regulations

### Chapter 1—Team Composition

Article 22—Team Formation .....	8
Article 23—Team Configuration .....	8
Article 24—Team Captains .....	8
Article 25—Stable Managers .....	8
Article 26—Mount Specifications .....	8
Article 27—Chaperones/Emergency Contacts .....	8
Article 28—Coaches and Coaching .....	9

### Chapter 2—Competition Levels and Divisions

Article 29—Competition Levels .....	9
Article 30—Competition Divisions .....	9
Article 31—Championships Divisions—Minimum Age and Certifications .....	9
Article 32—Championships Eligibility Process .....	9
Article 33—Eligibility Requirements for C-3, B, H-A/A Certified Members .....	10
Article 34—Exceptions to Competition Eligibility Requirements for Championships .....	10

### Chapter 3—Presentation of Competitor and Mount

Article 35—Competitor Identification .....	10
Article 36—Competitor Attire .....	10
Article 37—Bits, Saddlery and Equipment .....	12
Article 38—Competitor and Horse Inspections .....	13

## SECTION III: Competition

Article 39—Competition Format .....	14
Article 40—Competition Schedule .....	14

### Chapter 1—Arenas and Equipment

Article 41—Arena Specifications .....	14
Article 42—Warm Up Area .....	14
Article 43—Race Equipment .....	14

### Chapter 2—Rules Governing the Races

Article 44—General .....	15
Article 45—Starting and Finishing .....	15

### Chapter 3—Types of Races

Article 46—Races .....	15
------------------------	----

### Chapter 4—Time

Article 47—Timing .....	34
Article 48—Recording Time .....	34

## SECTION IV: Scoring

Article 49—Points and Penalties .....	35
Article 50—Inquiries, Protests and Appeals .....	35
Article 51—Scoring of Excused .....	36
Article 52—Scoring of Elimination .....	36
Article 53—Scoring of Disqualification .....	36
Article 54—Team Scoring .....	37
Article 55—Individual Scoring .....	37
Article 56—Posting Scores .....	37
Article 57—Placing of Teams .....	37

## SECTION V: Officiation

Article 58—Rally Organizer .....	38
Article 59—Technical Delegate (TD) .....	38
Article 60—Discipline Ground Jury .....	38
Article 61—President of the Discipline Ground Jury .....	39
Article 62—Championships Overall Ground Jury .....	39
Article 63—Horse Management Judges .....	39
Article 64—Chief Horse Management Judge (CHMJ) .....	39
Article 65—Spotters .....	39
Article 66—Chief Judge .....	39
Article 67—Inspection Panel .....	39
Article 68—Veterinarian .....	39
Article 69—Chief Scorer .....	40
Article 70—Required Medical Personnel .....	40

# Table of Contents

---

## SECTION VI: Appendices

Appendix I: Mounted Competition Scoring Inquiry/Protest/Appeal Form	41
Appendix II: Heat Illness and Heat Index Chart.....	43
Appendix III: Chaperone and Emergency Contact Information.....	44
Appendix IV: Junior/Senior Team Formation.....	47
Appendix V: USPC Gymkhana Rally TD's Report.....	48
Appendix VI: Gymkhana Coaching Guidelines Form.....	51
Appendix VII: Gymkhana Yellow (Warning) Card.....	52

**Reminder:** This is a new Rulebook for 2024. Additions, deletions and changes have been made since the last rulebook was issued. Be sure to read the entire publication carefully so you will be aware of all the rules for the upcoming rally season.

*This rulebook should be kept in a 3-ring binder to allow for addition of revisions and new instructional sections. Do not remove pages from your rulebook; be sure to make copies of all forms and charts before writing on them.*

These rules are based on copyrighted Rules of the U.S. Equestrian Federation and are printed with the permission of the USEF, which neither sponsors nor is responsible for their publication or implementation at any United States Pony Club event.

# SECTION I: USPC Uniform Officiation Rules

---

## Article 1—Rally Definition

Pony Club rallies are team competitions, whether competing unmounted or mounted. All mounted rallies (standard and modified) must include riding and Horse Management competitions. Mounted rallies may run within the framework of a local or recognized show. A rally may take place all in one day or may span several days.

This rulebook is intended to establish standards for United States Pony Clubs (USPC) rallies. Organizers of competitions should work with their regional supervisors (RS) to offer the levels and divisions that they feel are appropriate for their local needs. It is the responsibility of the organizer and RS to offer the appropriate standard or modified rallies and divisions for their members wishing to become eligible for Championships.

Regions may host more than one rally per discipline in the same year. In modified rallies and divisions, organizers and RSs may make rule allowances based on the competitor's needs. Competitors aiming for Championships must strictly follow all attire and equipment specifications. Organizers must outline any rule adjustments in the entry information. Criteria for standard and modified rallies are listed below.

### Standard Rallies

Standard rallies are always preferred. These rallies specifically follow all the rules outlined in the discipline rulebooks including utilizing a Chief Horse Management Judge (CHMJ) from the approved CHMJ list on the USPC website, and any other specified licensed officials. Certain divisions of Championships require the member to attend a standard rally.

### Modified Rallies

Modified rallies do not **explicitly** follow the discipline rulebooks and generally occur because of limited resources. Attendance of a modified rally makes some members eligible for the modified divisions of Championships.

Each year, regions should host rallies and are encouraged to work cooperatively with other regions to host joint rallies as appropriate. At all levels, organizers are encouraged to keep rallies simple and inexpensive. Local and regional rallies are team competitions involving club/centers from only one region. Interregional rallies are team competitions between two or more regions.

If an individual's region does not offer a rally in the desired discipline, they may earn eligibility in another region upon obtaining approval from the RS in both regions.

Rally competitions **are normally held in a team format**, but sometimes members compete as individuals based on the needs of the hosting group. In all rallies, teams should be recognized for their achievements in the competition. In mounted rallies, team/competitor placings will be based on a combination of their riding scores and their Horse Management scores. Separate Horse Management awards are often given for the team/individual with the lowest Horse Management penalties.

## Article 2—Governing Rules

With regards to standard rallies, this rulebook is a precise specification of rules that must be followed. For modified rallies/divisions/competitors, this rulebook should be viewed as a guide that can be adjusted by the rally organizer/RS to best meet the needs of the region. Modifications should be listed in the rally entry information. Additional governing documents for all rallies are the following:

- Annual Discipline Newsletters
- USPC Horse Management Handbook (current edition)
- Official Amendments and Clarifications from USPC
- Appropriate parent organization rulebooks (i.e. USEF, APA). If the rally is being run in conjunction with a recognized event, the parent organization rulebook will supersede this rulebook. If the rally is not being run in conjunction with a recognized event, then this rulebook is to be followed.

Since rules cannot provide for every eventuality (unforeseen or exceptional circumstance), it is the obligation of the discipline ground jury to make decisions in a sporting spirit and to follow as closely as possible the intention of these rules. If there is an inconsistency, the discipline rulebook takes precedence over the Horse Management Handbook.

These rules are based on copyrighted rules of the U.S. Equestrian Federation (USEF) and are printed with the permission of USEF, which neither sponsors nor is responsible for their publication or implementation at any USPC event.

## Article 3—Responsibility

All competitors are ultimately responsible for knowing these rules and complying with them. The appointment of an official, whether or not provided for in these rules, does not absolve the competitor from such responsibility.

## Article 4—Legal Liability

Neither the USPC, host club/center/region(s), the organizer, competition officials, staff, nor any other person acting on behalf of the organizer, shall be held liable for any loss, damage, accident, injury or illness to competitors, mounts or to any other person or property whatsoever.

# SECTION I: USPC Uniform Officiation Rules

---

## Article 5—Member Participation and Eligibility

### Participation in Rallies:

At local, regional, and inter-regional rallies participants

- May be of any age or certification
- Must be a member in good standing, must have paid all local, regional, and national dues, insurance fees
- Membership be on record with the USPC National Office at the time of the rally

Members, parents, and anyone participating in USPC activities must all abide by the applicable Code of Conduct. Members seeking Championships eligibility must meet the eligibility criteria outlined in this document. The member's age as of January 1 shall be the age of record throughout the competition year.

Competitors and mounts are expected to participate in all aspects of the rally including briefings, horse inspections, mounted competition, and Horse Management. For overnight rallies, all mounts are expected to stay on the competition grounds unless the competitor makes other arrangements with the rally organizer prior to the start of the competition.

While competitors are expected to participate fully in the rally, they are encouraged to get out of the barn if their mount is properly cared for with food and water. Based on the competition schedule, competitors may leave the rally grounds during competition hours.

If a mount is removed from the competition grounds without prior consultation with the rally organizer, the competitor may be penalized by the ground jury.

### Championships Competitor Age and Certification:

Each discipline/division has minimum age and certification requirement for participation in Championships. Championships competitors must meet the age requirement based on January 1 of the Championships' competition year. They must have competed at the minimum or higher certification level at a standard or modified rally. Any standard rallies should base their division entry status on the competitor's age for the following year and all rallies should take into account planned advancements in certification level.

District commissioners (DCs) and center administrators (CAs) are responsible for the eligibility of competitors and mounts at all rallies. It is the responsibility of DCs/CAs and club/center primary instructors to see that

- Mounts and riders are entered in rallies at the appropriate level
- To make all competitors aware of health requirements i.e., Coggins, immunizations and state health certificates with valid dates,
- To see that entry forms are complete and submitted to the rally secretary on time.

- All Pony Club members in their jurisdiction have access to a copy of the current USPC discipline rulebook, current USPC Horse Management Handbook (HMH), current USPC discipline annual newsletter(s) and any other relevant information from the USPC discipline committees or the organizer of a specific rally where they will be competing.

## Article 6—Member in Good Standing

(Policy 1002) Members are considered in good standing if they are current with all dues and fees owed the registered club/riding center program, region, **USPC, and have met all compliance requirements.**

## Article 7—Code of Conduct Expectations

The officials of the competition may immediately suspend or expel any individual from the competition upon consulting with the discipline ground jury **for anyone not conforming to the Code of Conduct.**

DCs, CAs, RSs, rally organizers, officials and judges must be familiar with, and enforce, the Participating Member and Adult Code of Conduct.

### Participating Member Code of Conduct

The United States Pony Clubs, Inc. is proud of its reputation for good sportsmanship, horsemanship, teamwork and well-behaved members. The USPC expects appropriate behavior from all members, parents and others participating in any USPC activity. Inappropriate behavior may include, but is not limited to: possession, use or distribution of any illegal drugs or alcohol; profanity, vulgar language or gestures; harassment (i.e., using words or actions that intimidate, threaten or persecute others before, during or following USPC activities); failure to follow rules; cheating; and abusing a mount.

### Adult Code of Conduct

The United States Pony Clubs, Inc. is proud of its reputation for good sportsmanship, horsemanship, teamwork and well-behaved members. It expects no less from the parents, guardians, adult family members or others who volunteer for the organization. The USPC expects appropriate behavior when participating in any Pony Club activity. Inappropriate behavior may include, but not be limited to: profanity, vulgar language or gestures; harassment (for example: using words or actions that intimidate, threaten or persecute others before, during or following any Pony Club activity); failure to follow rules; cheating; or abusive behavior.

*"I understand that USPC activities operate under the governance of USPC and are subject to all applicable USPC By-laws, Policies, Rules and Regulations. I understand that I have access to these By-laws, Policies, Rules and Regulations and that it is my responsibility to read them. I agree to adhere to these By-laws, Policies, Rules, Regulations and this Code of Conduct. Failure to do so may, at the discretion of USPC, result in being restricted from attendance or participation in Pony Club activities."*

# SECTION I: USPC Uniform Officiation Rules

---

## Article 8—Substances and Weapons

(Policy 0500) In the interest in the safety and welfare of all, it is the policy of the Board of Governors, during any Pony Club activities, to prohibit the inappropriate or illegal use of any substance, including but not limited to drugs or alcohol, by anyone participating in any manner. Weapons of any kind are forbidden.

## Article 9—Mounts

(Policy 0840) Mounts used at a regional or interregional rally should be the participant's regular USPC mount, and accustomed to being handled by its rider without adult supervision. A participant may use a different mount only with the advance permission of the DC/CA and RS.

Ownership of a mount is not a prerequisite for membership in USPC. The responsibility for obtaining a suitable mount for mounted activities rests with the **individual** or parents/guardians of the individual member.

Per USPC Policy 0840 suitable mounts are defined as follows:

1. Stallions are not considered suitable mounts.
2. Mounts must be serviceably sound, in good overall health and in condition for the activity in question.
3. Mounts must be appropriate for the certification level of the rider and must be at a level of training to participate safely in the activity.
4. Except as noted below, mounts must be at least five (5) years of age in order to participate in USPC competitive, instructional, and recreational programs and activities. In establishing the age of mounts, the first year is considered to be January 1 following the date of foaling.
5. Members holding a riding certification of C-1 and above may participate in all USPC activities on an appropriate mount at least four (4) years of age.

A mount must be excused from any activity if in the opinion of the instructor, examiner, or appropriate authority, it is unsafe either to its rider or to other riders or mounts.

## Article 10—Substitution of Mounts

For all mounted rallies (except Tetrathlon), mount and rider become eligible for Championships as a team. Therefore, a competitor must enter Championships only on the mount on which they earned eligibility.

In extraordinary circumstances, after becoming eligible for Championships, a substitute mount may be requested via the online application a minimum of five days before Championships move-in by the RS. The panel reviews each application to verify the substitute mount meets the same mount eligibility requirements as the original entry. Refer to the Mount Substitution application found on the USPC website.

- Mounted Games and Polocrosse teams may bring a spare mount for the competition. See Section II and III for additional information (Discipline Rulebooks).
- Tetrathlon mounts need not have participated in a regional rally prior to Championships participation.

## Article 11—Sharing of Mounts

In some disciplines and in some competitions, the sharing of mounts may be allowed. At regional rallies, the rally organizer in consultation with the RS may allow for the sharing of mounts by competitors. For Championships, requests for shared mounts must be submitted using the Mount Substitution online application found on the USPC website. Each request will be reviewed on a case-by-case basis, for approval or denial. Determination of shared mounts must take into consideration the discipline, competition schedule, and suitability of mount. The welfare of the mount will be the highest priority in this situation and all competitors must agree that if the horse management, judges, technical delegate (TD)/steward, or organizers onsite feel that the health of the mount is in jeopardy at any time that they may be removed from the rest of the riding portion of the competition.

## Article 12—Veterinary Care and Medications

(Policy 0860 and 0860 P.1) To promote the safety and welfare of Pony Club members, their mounts, and provide fair and unbiased competitions, the Policy of the Board of Governors is that all mounts in USPC sponsored activities be serviceably sound and healthy. The definition of serviceably sound may vary based on the mount's duties and competition level.

Medications may be administered to mounts, provided their use does not create an unfair advantage or allow an unfit mount to participate as determined by the rally officials.

It is the owner/rider's responsibility, in coordination with a veterinarian, to determine what medication(s) are appropriate.

Competitors participating in USPC rallies held in conjunction with other competitions may be subject to medication rules of other organizations in addition to those of USPC.

### Additional requirements and information:

- Any mount receiving medication for chronic conditions must have medications listed on their stall card.
- Mounts requiring medications for acute conditions treated by a veterinarian, the competitor/parent, or owner, must coordinate with responsible party for the activity or Horse Management staff prior to administration.
- Medication is defined as any substance that is not water, salt, electrolytes, or a supplement and is not considered a normal foodstuff.

## Article 13—Cruelty to and Abuse of a Mount

Cruelty to or the abuse of a mount present on the grounds of any competition is forbidden and renders the offender subject to

# SECTION I: USPC Uniform Officiation Rules

---

penalty. The organizing committee **will** bar violators from further participation for the remainder of the competition.

Any action(s) against a mount by a competitor or other person, which are deemed excessive by a judge, steward, TD or competition veterinarian, in the competition ring or anywhere on the competition grounds may be punished by official warning, elimination, or other sanctions which may be deemed appropriate by the organizing committee. Such action(s) may include, but are not limited to excessive use of the whip or spurs.

USPC, judges, stewards, or TDs may appoint a veterinarian to inspect any animal on competition grounds or entered to compete. Refusal to submit an animal for examination by an authorized veterinarian after notification shall constitute a violation.

The following are included under the words cruelty and abuse but are not limited thereto:

1. Abuse. Any act or series of actions that, in the opinion of a judge, TD, steward, member of the discipline ground jury or other rally official can clearly and without doubt be defined as abuse of mounts shall be penalized by disqualification. Such acts include, but are not limited to:
  - Riding an exhausted mount.
  - Excessive pressing of a tired mount.
  - Excessive use of whip and/or spurs, and/or bit.
  - Striking a mount in front of the shoulder.
  - Riding an obviously lame mount.
2. Rapping. All rapping (poling) is forbidden.
3. Whip. The use of the whip must be for a good reason, at an appropriate time, in the right place, and with appropriate severity.
  - Reason—The whip must only be used either as an aid to encourage the mount forward, or as a reprimand. It must never be used to vent a rider's temper. Such use is always excessive.
  - Time—As an aid, the only appropriate time is when a mount is reluctant to go forward under normal aids of the seat and legs. As a reprimand, the only appropriate time is immediately after a mount has been disobedient, e.g., napping or refusing. The whip should not be used after elimination. The whip should not be used after a mount has jumped the last fence on a course or completed the last obstacle.
  - Place—As an aid to go forward, the whip may be used down the shoulder or behind the rider's leg. As a reprimand, it must only be used behind the rider's leg. It must never be used overhand, e.g., a whip in the right hand being used on the left flank. The use of a whip on a mount's head, neck, etc., is always excessive use.
  - Severity—As a reprimand only, a mount may be hit hard. However, it should never be hit more than two times for any one incident. If a mount is marked by the whip, e.g., the skin is broken, its use is excessive.

4. End of the Reins (Trail only) - The use of the end of the reins must be for a good reason, at an appropriate time, in the right place, and with appropriate severity.

- Reason—The end of the reins must only be used either as an aid to encourage the mount forward, or as a reprimand. It must never be used to vent a rider's temper. Such use is always excessive.
  - Time—As an aid, the only appropriate time is when a mount is reluctant to go forward under normal aids of the seat and legs. As a reprimand, the only appropriate time is immediately after a mount has been disobedient, e.g., napping or refusing. The end of the reins should not be used after elimination.
  - Place—As an aid to go forward, the end of the reins may be used down the shoulder or behind the rider's leg. As a reprimand, it must only be used behind the rider's leg. It must never be used overhand, e.g., the end of the reins in the right hand being used on the left flank. The use of the end of the reins on a mount's head, neck, etc., is always excessive use.
  - Severity—As a reprimand only, a mount may be hit hard. However, it should never be hit more than two times for any one incident. If a mount is marked by the end of the reins, e.g., the skin is broken, its use is excessive.
5. Spurs—Spurs must not be used to reprimand a mount. Such use is always excessive, as is any use that results in a mount's skin being broken.
6. Bit—The bit must never be used to reprimand a mount. Any such use is always excessive.
7. Reporting—Officials must report such actions as soon as possible to the discipline ground jury, supported where possible by statements from witnesses.
- Discipline ground jury—if such actions are reported, the discipline ground jury shall decide if there is a case to be answered. If an individual member of the discipline ground jury observes such actions, they are obliged to disqualify the competitor forthwith on their own authority. There is no appeal against a discipline ground jury's decision in a case of abuse.

## Article 14—Dangerous Riding

1. Any competitor who rides in such a way as to constitute a hazard to the safety or wellbeing of the competitor, mount, other competitors, their mounts, spectators, or others will be penalized accordingly.
2. Any act or series of actions that in the opinion of the judge, TD, steward, member of the discipline ground jury can be defined as dangerous riding shall be penalized at the discretion of the discipline ground jury.
3. If such actions are reported, the discipline ground jury shall decide if there is a case to be answered. There is no appeal against a discipline ground jury decision.



# SECTION I: USPC Uniform Officiation Rules

---

## Article 15—Safety

(Policy 0800) USPC is committed to safety while recognizing that equestrian activities are inherently dangerous. The USPC Safety Handbook is an excellent resource for making safety a priority at all rallies and Pony Club functions. This dedication to safety extends to requiring certain equipment be utilized during Pony Club activities and include:

1. Protective Headgear (Policy 0810): USPC requires members participating in mounted and some unmounted activities to wear a properly fitted equestrian helmet, securely fastened, containing certification that it meets the criteria established by the following international or national safety bodies:
  - ASTM F1163 with SEI Mark (North America)
  - SNELL Memorial Foundation E2016 or E2021
  - AS/NZS 3838 with SAI Global Mark
  - PAS 015 with BSI Kitemark.
2. Safety Vest/Body Protector (Policy 0830): USPC requires members to wear a properly fitted equestrian body protector when jumping cross-country or solid obstacles during any activity sponsored by the USPC, its regions, registered clubs or riding center programs. A member may wear a body protector at their discretion for any mounted activity.
3. Medical Armbands and Bracelets (Policy 0820 and 0820P):
  - USPC requires that members participating in any USPC affiliated mounted or unmounted activity, must wear either a medical armband or medical bracelet while participating in the activity. The member may choose which one to wear.
  - Medical armbands must include a current completed copy of the individual's USPC or USEA Medical Card. It must be worn on the upper arm. If the member has small arms, they may safety pin the armband to their upper sleeve. (Armbands are available for purchase from Shop Pony Club.)
  - Medical bracelets must visibly list these six items on them: name, date of birth, contact information, known allergies, current medications, and existing medical conditions. More information is acceptable, but these six items are required to be on the bracelet
  - All officials on site at the USPC mounted or unmounted activity are encouraged to work with the competitors to remind them of this requirement.
  - Any member at a USPC affiliated mounted or unmounted activity\* found not wearing either a medical armband or medical bracelet must be removed from the activity until the member conforms to the policy requirement.

*\*Tetrathlon competitors will not be required to wear them while actually shooting or swimming but must have them visible and next to them for these activities and must wear them at all other times.*

4. Unmounted Footwear: When working in the barn or near mounts unmounted footwear must meet all the following criteria:

- Thick-soled, shoes/boots (short or tall)
- Cover the ankle
- In good condition
- Made of leather or synthetic materials
- Entirely closed
- Securely fastened
- Well-fitted to foot
- Sturdy construction (e.g., Ugg-type boots do not meet this requirement)

Examples: paddock/jodphur boots, rubber riding boots, rain boots/wellies, western boots.

5. Smoking: In the interest of barn safety, it is strictly forbidden for anyone to smoke in or around barn and stable areas.

## Article 16—Heat-Related Information

(Policy 0900): USPC requires all Pony Club volunteers in a leadership position within Pony Club and especially anyone involved directly with mounted or unmounted lessons or activities to complete the Centers for Disease Control and Prevention (CDC) heat illness training module.

At all USPC activities, rally officials must consider the:

- Temperature and humidity using the "Heat Index Chart" (Appendix II).
- Time of day and season of activity.
- Level of exertion necessary for participation in the activity.

The Heat Index (HI) or "Apparent Temperature" is the temperature the body feels when heat and humidity are combined. This reduces the amount of evaporation of sweat from the body and outdoor exercise becomes dangerous even for those in good shape. Please refer to Appendix II.

Steps to prevent heat-related illness include:

- Providing unlimited cool water for consumption in ALL areas, especially riding areas.
- Make water breaks mandatory.
- Do not depend on thirst as an indicator of the need for water.
- Avoid the hottest part of the day if this is an option.
- Consider shortening the length/level or exertion of the activity.

During rallies, the discipline ground jury (overall ground jury at Championships) is responsible for monitoring the Heat Index and taking appropriate action as necessary. Those actions could include, but are not limited to:

# SECTION I: USPC Uniform Officiation Rules

---

- Waiving of coats/jackets
- Banning of coats/jackets
- Altering of schedule

Any official can and should bring a potentially dangerous heat situation to the attention of the president of the ground jury. If coats/jackets are waived or banned the following processes should be followed.

## Waived Coats/Jackets

When the temperature and humidity are recorded in the danger zone, removal of coats during warm up is mandatory.

If the rider wants to put their coat/jacket on for their competition round, then they may leave their neckwear and helmet cover on during warm up.

If the rider does not want to put their coat/jacket on for their competition round, then they must remove all neckwear and their helmet cover during warm up.

## Additional Information

- When coats are waived, the competitors must be turned out per Competition Attire (including coats/jackets) unless they choose to compete wearing Basic Riding Attire.
- Riders must wear a collared shirt with long or short sleeves if they are not wearing a jacket.
- T-shirts are not permitted.

Competitors must also remove neckwear and helmet covers on vented helmets if they do not wish to wear their jackets for their competitive ride.

## Banned Coats/Jackets

When temperature and humidity are recorded in the danger zone and based on the decision of the discipline ground jury (overall ground jury at Championships) coats/jackets may be banned for the safety of competitors. If coats/jackets are banned then competitors must remove coats/jackets, neckwear and helmet covers for turnout inspections, warm up and for competition rounds.

## Heat-Related Illness Return To Play

A member believed by a leader, coach, parent or official of a USPC unmounted or mounted activity or competition to be suffering from heat illness shall be removed from play at that time and given appropriate treatment before being allowed to return to play.

## Article 17—Concussion and Return to Play

(Policy 0900): USPC requires all Pony Club volunteers in a leadership position within Pony Club and especially anyone involved directly with mounted or unmounted lessons or activities to complete the concussion training module.

A member believed by a leader, coach, parent or official to have sustained a concussion during a USPC unmounted or mounted activity must be referred to medical personnel. Medical personnel in conjunction with rally officials and organizers will determine if a written release is required for the member to return to the competition.

## Article 18—Unauthorized and Permitted Assistance

1. Unauthorized Assistance: Unauthorized assistance is help and/or assistance during the competition from anyone other than other competitors, HMJs, and rally officials. Unauthorized assistance can occur in person or through the use of electronic communication, unless allowed by the specific discipline rulebook (e.g., coaches in certain situations)
2. If, in the opinion of a member of the ground jury, unauthorized assistance has been received by a competitor, that competitor may be eliminated from that phase of the rally, or in extreme cases, disqualified from the competition. The discipline ground jury makes the final decision. There is no appeal.
3. Permitted Assistance:
  - Adults may aid in the unloading of mounts and carrying of heavy gear into the stable area upon arrival, after which non-competitors must immediately leave the area.
  - After a fall of a competitor or dismount, they may be assisted to catch their mount, to adjust their saddlery, to remount, or to be handed any part of their saddlery or equipment, including whip, while they are dismounted or after they have remounted. Helmets must be replaced, and retention harnesses refastened before riders may remount.
  - A competitor may receive clarification of jumping penalties from an obstacle judge, e.g., after jumping a flag at a corner, the judge may clarify whether it was a run-out or not.
  - If bodily harm to mount and/or rider is imminent, assistance from anyone (official or otherwise), without concern for penalties, is expected. Time permitting, the situation should be brought to the attention of an official. If immediate intervention is necessary, then an official will be notified as soon as possible concerning the situation.
  - If a mount is ill or injured, the owner/agent of the mount will be called in to discuss care.
  - Exception for loose mounts in Mounted Games only: In Mounted Games, a loose mount may be caught by any competitor or official already in the arena when the loose mount is behind Lines A and C. However, only the mount's rider may enter the playing area to catch it.

# SECTION I: USPC Uniform Officiation Rules

---

## Article 19—Excused

1. May also be called a “Technical Elimination”
2. To grant permission to, or request that a competitor leave the phase/round/game due to circumstances outside of the competitor’s control (e.g., illness of rider, illness or lameness of mount)
3. Decided by
  - Inspection panel at mount inspection
  - Judge
  - Discipline ground jury
4. May not ride; therefore, will not receive any riding score during the excuse, but
  - May request a lameness recheck
  - Rider may request to compete in following phases/rounds/games after if illness passes.
  - Both the mount and rider shall stay on rally grounds (unless the mount is transported for medical reasons) and continue to participate with the team and continue to be scored in Horse Management.
  - If ill, mount will be moved to another area, if possible.

## Article 20—Elimination

- Elimination means to exclude a competitor or mount, for cause, from judging consideration in a class/phase. Competitor not scored in a class due to a mistake (e.g., use of illegal equipment, violation of the rules of phase/rounds/ games.)
- After elimination, the discipline ground jury in consultation with the organizer, may allow participation in subsequent phases/rounds/games.
- Determined by judge or discipline ground jury.
- Refer to scoring of penalties for additional discipline specific reasons for elimination.

## Article 21—Disqualification

Disqualification is a punishment for misconduct arising from a deliberate attempt to contravene the rules and regulations of USPC applied at the discretion of the discipline ground jury. Any disqualified competitor and their mount may not take further part in the competition including in Horse Management.

Reasons for disqualification include, but are not limited to:

- abusive or unsportsmanlike conduct
- obscene or inappropriate language
- the inappropriate or illegal use of drugs (other than those prescribed by a physician), alcohol, or tobacco (Article 8)
- rude and disruptive behavior
- cheating
- cruelty (Article 13)
- rough or dangerous riding
- knowingly riding a lame, sick, or exhausted mount
- misuse of equine medications (Article 12)

If a rally official identifies a competitor behaving in a way that could lead to disqualification, that official may issue a written warning to the competitor using Appendix VII, a Yellow Card. If the rally official believes the Yellow Card should have penalties attached to it, or that the competitor should be disqualified, they must refer the situation to the discipline ground jury.

The discipline ground jury shall investigate the situation and interview the competitor(s) and all applicable witnesses before making a final decision on penalty points.

If a Yellow Card with penalty points is assigned to a competitor, it may not exceed a 50% impact on the associated phase/round score if related to a single phase/round, or a 50% impact on the overall score. There is no appeal against a discipline ground jury decision on issuing a penalty points or disqualifying a competitor.

Refer to Section V for additional discipline specific reasons for disqualification and scoring (Discipline Rulebooks).

# SECTION II: General Regulations

---

## Chapter 1—Team Composition

### Article 22—Team Formation

#### Regional Rallies:

The district commissioner (DC) or center administrator (CA) of local clubs/centers are responsible for club/center team formation at regional rallies. A team made up of members from one local club/center remains the ideal and is always the goal. Scramble teams made up of members from multiple clubs/centers are also accepted. The DCs/CAs of the clubs/centers involved may assist the rally organizer in forming scramble teams. RSs (RSs) may have final determination.

#### Championships:

The RS (or individual designated by the RS) is responsible for marking in the database all members who have earned eligibility for Championships regardless of their intent to participate.

As members register, the RS is responsible for putting together the teams based on the offered Championships divisions. A team made up of members at the same competition level, and from one region remains ideal and is always the goal.

Once registration closes, RSs lose the ability to merge teams. Based on the final competition numbers, the discipline secretary shall make the final adjustments to teams and scrambling of individuals without a full team. Requests for preferred teammates may be submitted but are not guaranteed

### Article 23—Team Configuration

1. Teams shall normally consist of 3 or 4 riding members and an unmounted stable manager. One member of the team will be designated as team captain. A competitor may serve as both the stable manager and team captain at the same time. The team members can all belong to one or possibly multiple divisions as determined by the rally organizer.
2. At the organizer's discretion, there may be an alternative configuration of teams based on entries.
3. The requirement of an unmounted stable manager may be waived at regional rallies by the RS.

### Article 24—Team Captains

Each team entered in the competition shall have one member designated as team captain who shall act as spokesperson for the team. Only the team captain may lodge a protest on behalf of any team member (see Article 50).

The team captain is responsible for all communications between the team and rally officials. The team captain may participate in any drawing (if held) for starting order. In the event of an inquiry, protest or appeal, the captain represents the team. The competitor involved should accompany the captain. It is the responsibility of team captains to ensure that their team members follow all rules and regulations of the competition and to transmit to them any changes or additional instructions provided by rally

officials. Any withdrawal of a team member must be reported to the TD/steward.

Teams losing a team captain to illness must designate another team member to take over the responsibilities of captain. If the original captain returns, they will resume the responsibilities of captain.

### Article 25—Stable Managers

At Championships, a non-riding stable manager is required. At regional rallies, non-riding stable managers are highly recommended, but riding stable managers may be allowed at the discretion of the RS. The stable manager works closely with the team captain to coordinate preparations for the rally, in addition to assisting in keeping the team organized and on schedule during the competition.

### Article 26—Mount Specifications

All mounts entered in a USPC Rally must meet the requirements outlined in Article 9. In addition for Gymkhana competitions, mounts may not compete in more than one Gymkhana competition held on the same day(s). Competitors may not share mounts in Gymkhana competitions held on the same day(s).

- Mounts must be familiar with the races to be ran.
- The chief judge shall disqualify any mount that is, in its opinion, lame, unruly or otherwise unsuitable for competition. In this case the chief judge's decision is final and may not be challenged.

### Article 27—Chaperones/Emergency Contacts

All competitors below the age of majority must have an official chaperone, 21 years of age or older, listed with rally organizers. All competitors above the age of majority must have an emergency contact, who is available during the competition, listed with the rally organizers. Please review the following criteria for chaperones and emergency contacts.

1. Chaperones:
  - Any team with a competitor under the age of majority must have an official chaperone, 21 years of age or older, designated for the competition.
  - The chaperone will act as the contact person for that team and must always be on the rally grounds during competition hours.
  - Several individuals may share one team's chaperone duties, but only one name will be listed as the official chaperone. All persons sharing this duty should be made aware of this name and answer to it.
  - The chaperone should serve as a volunteer for the competition but may not assume coaching duties.
  - Anyone serving as team chaperone must understand and agree to the duties outlined in Appendix III.

# SECTION II: General Regulations

## 2. Emergency Contacts:

- Any competitor above the age of majority must submit a completed Emergency Contact Form (Appendix III) with their entry.
- Those listed as an emergency contact must be available by phone during the competition.

## Article 28—Coaches and Coaching

Gymkhana coaches are allowed, but not mandatory for all rallies. There may be one or more coaches (may not also serve as chaperone). The presence of a coach at a Gymkhana rally is to promote safety, good sportsmanship and good horsemanship in the warm-up area and the competition ring. Coaches are expected to help any Pony Club competitor who asks for assistance or whose coach is not present in the warm up area.

Competitors in a rally may also coach other competitors, providing they meet the following criteria:

- Must be 18 years of age as of January 1st of the competition year.
- No scheduling changes will be made to accommodate the coaches/competitors ride times.
- Competitor's responsibilities and mount's care always takes precedence over coaching duties.

### Gymkhana Coaches:

- Must read, understand, sign and return a Coaches Form with the team entry. (Appendix VI)
- Must know the USPC Gymkhana rules, especially regarding unauthorized assistance, Article 18. Access to the team is limited and they may not enter the stable area except during authorized visiting times.
- At Championship competitions, coaches must attend the opening competitor briefing, and any coaches briefings.

## Chapter 2—Competition Levels and Divisions

### Article 29—Competition Levels

At regional rallies a rider may ride at any level offered, in which they feel their mount would be able to perform. Below are the most commonly offered levels at Gymkhana rally:

- Walk-Trot\*
- Novice
- Intermediate
- Advanced

*\*Leaders for Walk-Trot must be at least 14 years of age by January 1 of competition year and be dressed in USPC approved barn attire. Leaders may not touch or reset any equipment.*

## Article 30—Competition Divisions

Competition divisions differ from competition levels in that competitors may be separated into divisions based on age and/or other parameters. A competitor's age is determined by their age as of January 1 on the year of competition. See Article 5 for more details on age minimums.

Junior Divisions—Up to and including 17 years of age

Senior Divisions—18 years of age and above

**Note:** Rally divisions can be combined based on entry numbers and approval of the organizer and RS. Junior competitors can always compete up a division as a senior to fill out a team. Senior competitors can never compete down in a junior division. Before combining junior and senior aged competitors on the same team, rally organizers must get the approval of the junior competitor and their parent/legal guardian (Appendix IV).

## Article 31—Championships Divisions—Minimum Age and Certifications

To be eligible for Championships, competitors must meet the age parameters and minimum certifications for the offered Championships divisions. Age is as of Jan. 1 of the competition year, and there are no age and no certification exceptions to the below requirements. See Article 5 for more details on age and certification minimums.

### Modified Championships Divisions

Division	Level	Age	Certification
Junior	Novice	10-17	D-2 DR, EV, EV1, HSE, WST, WDR
Senior	Novice	18+	
Junior	Intermediate	10-17	
Senior	Intermediate	18+	

### Standard Championships Divisions

Division	Level	Age	Certification
Junior	Intermediate	12-17	C-1 DR, EV, EV1, HSE, WST, WDR
Senior	Intermediate	18+	
Junior	Advanced	12-17	
Senior	Advanced	18+	

**EV1 - Also known as Eventing Phase 1 (formerly known as Eventing Flat). Please check your certification on your profile to be sure it is reflected properly**

Stable Managers must meet the minimum age criteria of their division, and be a D-2 HM for modified divisions and a D-3 HM for all other divisions.

**Note:** Championship divisions may be combined based on entry numbers and approval from Vice President of Activities (VPA) and the overall organizer.

# SECTION II: General Regulations

---

## Article 32—Championships Eligibility Process

Each individual Pony Club member who desires to compete at Championships must compete in a regional rally and be judged at the minimum HM level and same competition level in which they intend to compete at Championships. This constitutes the “individual eligibility” of the competitor.

Members wanting to become eligible for Championships must meet the below division criteria.

**Modified Novice**—Complete a standard or modified Gymkhana rally at the competition level, with a minimum of four unique races.

**Modified Intermediate**—Complete a standard or modified Gymkhana rally at the competition level, with a minimum of four unique races.

**Intermediate**—Complete a standard Gymkhana rally at the competition level, with a minimum of four unique races.

**Advanced**—Complete a standard Gymkhana rally at the competition level, with a minimum of four unique races.

If a standard or modified Gymkhana rally is not available. Competitors may also earn competitive eligibility using the following process.

1. Must attend a standard regional rally to receive a mounted HM score.
2. Must attend a breed show, play day, club show, NBHA, 4-H show, speed show or other similar competition.
3. Must complete in a minimum of four unique races that are listed in the Gymkhana rulebook and receive a time.
4. In the event a race receives a no time, that race will not count toward the minimum 4 unique races.
5. Must wear a helmet meeting USPC Policy (Article 15.1) at all times while mounted at the competition, regardless of competition rules.

## Article 33—Eligibility Requirements for C-3, B, A Certified Members

Certified C-3, B, and A members wishing to compete at Championships do not have to become eligible at a regional Gymkhana rally but must have permission of their RS.

## Article 34—Exceptions to Competition Eligibility Requirements for Championships

Exceptions to the competition eligibility process are occasionally granted. There are no exceptions to minimum age and certification requirements. The process for requesting an exception is outlined on the USPC website. All requests for exceptions must come from the RS to the review panel using the online application found on the USPC website.

## Chapter 3—Presentation of

## Competitor and Mount

### Article 35—Competitor Identification

Identification numbers (pinnies, bridle numbers, etc.) must be worn in a prominent manner on the competitor or mount, as designated by rally officials. Pinnies must always be worn in the barn area. Competitor nametags must always be worn, except when mounted.

### Article 36—Competitor Attire

Each participant is responsible for organizing their own attire and equipment which must meet all safety requirements outlined in Article 15. Competitors should be neat and clean with inappropriate jewelry not permitted; see Horse Management Handbook for specifications. Participants must wear a medical armband or bracelet as specified in Article 15.3. A Pony Club pin must be worn at all times unless otherwise stated by rally officials. Felt can be placed behind pins using the below designations:

Certification	Felt Color
A.....	Royal Blue
H-A.....	Orange
B.....	Red
H-B.....	Brown
C-3.....	White
C-1 and C-2.....	Green
D-1 through D-3.....	Yellow

Depending on the activity, different attire expectations exist. The different situations and attire expectations are listed below.

1. **General Barn Attire**—Attire must be safe, free of rips and tears. Shirts must have sleeves to the point of the shoulder or longer and appropriate unmounted footwear.
2. **Horse Inspection (Jog Outs)**—Attire must be safe, appropriate, neat and clean. It must include a helmet (meeting USPC Helmet Policy, Article 15.1), and appropriate unmounted footwear (Article 15.4). Workmanlike and discipline appropriate attire (English or Western) including a tucked in collared shirt with pants/skirt/mid-length shorts/riding pants/jeans. If the pants/skirt has belt loops a belt is required.
3. **Turnout Inspection and first round of competition**—All competitors must turnout and compete in appropriate competition attire. Any competitors not seeking Championships eligibility may turnout and compete in appropriate competition attire or in basic riding attire as detailed below. Attire requirements may be adjusted based on excessive heat as detailed in Article 15. In inclement weather, competitors will be allowed to wear a helmet cover and a transparent or conservative colored raincoat.
4. **Competition Attire for Gymkhana** allows competitors to decide between competing in Western attire/tack or in

# SECTION II: General Regulations

---

English attire/tack. Competitors must compete following all Western attire and tack rules or all English attire and tack rules. The mixing of Western and English attire or tack is not permitted. If an Australian stock saddle is used, it can be considered either Western or English and the rest of the attire/tack must be either all Western or all English.

Gloves—Any color.

Safety/Protective Vests—Any color.

## Western Competition Attire for Gymkhana

### Required

Helmet—Any color that meets the USPC Helmet Policy (Article 15.1).

Hair—Hair should be neatly secured (away from the eyes) and may not cover competitor number.

Shirt—A button down collared shirt of any color with sleeves, tucked into pants.

Pants—Any color jeans, or western riding pants.

Footwear—Footwear Conventional type of riding footwear, that covers the ankles (short or tall) with a heel.

Belt—Required if pants/skirt has belt loops. Trophy buckles smaller than 3 ½" x 5" are also permitted.

### Permitted

Helmet Covers—Any color.

Coat/Jackets—Any color, must be secured.

Safety/Protective Vests—Any color.

Gloves—Any color.

Chaps—Any color, any material, any length, any style.

Spurs—Western style with blunt tines or English style spurs.

### Not Permitted

Equitation suits, neckwear, or trophy buckles larger than 3 ½" x 5".

## English Competition Attire for Gymkhana

### Required

Helmet—Any color that meets the USPC Helmet Policy (Article 15.1).

Hair—Hair should be neatly secured (away from the eyes) and may not cover competitor number.

Shirt—A button down collared shirt or polo shirt of any color with sleeves, tucked into pants.

Breeches/Jodhpurs—Any color.

Belt—If breeches have belt loops, belts are required.

Footwear—Footwear Conventional type of riding footwear, that covers the ankles (short or tall) with a heel.

### Permitted

Coat/Jackets—Any color, must be secured.

Spurs—English style with blunt ends.

# SECTION II: General Regulations

---

## **Not Permitted**

Cowboy boots, full chaps, neckwear

5. Basic Riding Attire for Gymkhana:

## **Basic Western Riding Attire for Gymkhana**

### **Unrated and D-1**

#### **Required**

Helmet—Any color meeting USPC Helmet Policy (Article 15.1).

Hair—Hair should be neatly secured (away from the eyes) and may not cover competitor number.

Shirt—Collared shirt with sleeves and tucked in.

Pants—Long pants.

Footwear—Conventional type of riding footwear, that covers the ankles (short or tall) with a heel.

#### **Permitted**

Belt—Any type/color.

Gloves—Any type/color.

Safety/Protective Vests—Any color.

Spurs—As defined in Western Competition Attire.

### **D-2 and up**

Rider must be in safe, neat, and clean attire.

#### **Required**

Helmet—Any color meeting USPC Helmet Policy (Article 15.1).

Hair—Hair should be neatly secured (away from the eyes) and may not cover competitor number.

Shirt—Collared shirt with sleeves and tucked in.

Pants—Trousers, pants, or split riding skirt of any color.

Belt—If pants have belt loops, belts are required.

Footwear—Conventional type of riding footwear, that covers the ankles (short or tall) with a heel.

#### **Permitted**

Gloves—Any type/color.

Safety/Protective Vests—Any color.

Spurs—As defined in Western Competition Attire.

## **Basic English Riding Attire for Gymkhana**

### **Unrated and D-1**

#### **Required**

Helmet—Any color meeting USPC Helmet Policy (Article 15.1).

Hair—Hair should be neatly secured (away from the eyes) and may not cover competitor number.

Shirt—Collared shirt with sleeves and tucked in.

Pants—Long pants.

Footwear—Conventional type of riding footwear, that covers the ankles (short or tall) with a heel.

#### **Permitted**

Belt—Any type, color

Gloves—Any type, color

Half-chaps—Any type, color

Safety/Protective Vests—Any color.

Spurs—As defined in English Competition Attire.

### **D-2 and up**

#### **Required**

Helmet—Any color meeting USPC Helmet Policy (Article 15.1).

Hair—Hair should be neatly secured (away from the eyes) and may not cover competitor number.

Shirt—Collared shirt with sleeves and tucked in.

Pants—Breeches, jodhpurs (with garters) or riding pants.

Belt—If pants have belt loops, belts are required.

Footwear—Conventional type of riding footwear, that covers the ankles (short or tall) with a heel.

#### **Permitted**

Gloves—Any type, color

Half-chaps—Any type, color

Safety/Protective Vests—Any color.

Spurs—As defined in English Competition Attire.

## **Article 37—Bits, Saddlery and Equipment**

Gymkhana rallies allow competitors to decide between competing in Western tack/attire or in English tack/attire. Competitors must compete following all Western tack and attire rules or all English tack and attire. The mixing of Western and English tack or attire is not permitted. If an Australian stock saddle is used, it can be considered either Western or English and the rest of the tack/attire must be either all Western or all English.

All competitors must turnout and compete per the specific bits, saddlery and equipment rules outlined in this rulebook. Any competitors not seeking Championships eligibility may request bits, saddlery and equipment allowances from the rally organizer and RS.

The following restrictions begin upon arrival on the competition grounds and continue throughout the duration of the rally. All equipment must be properly fitted and consistent with their intended use.

### **Western Tack Specifications:**

#### 1. Bits, Bridles and Nosebands

There is no restriction on bits, bridles and nosebands. Any bit used in Pony Club should enable the Pony Club member to ride



# SECTION II: General Regulations

---

safely and to effect control without causing pain or injury to the mount. The misuse of any bit may be severely penalized by elimination, up to and including disqualification.

## 2. Reins

A single set of reins which are connected and have a snap or leather breakaway feature on both sides.

## 3. Saddles

Any color stock saddle, with fenders, with or without a horn. May be made of leather, synthetic, or combination of the two. Rear cinch is optional.

### **NOT Permitted**

Bareback pads, sidesaddles, trick riding saddles.

### **Extra Equipment**

#### **Permitted**

A breastplate/breast collar is recommended.

Crupper, running martingale (with rein stops), standing martingale, tie down (noseband must be made entirely of flat leather)

Seat savers

Bell boots of any color

Boots/wraps of any color,

Whip, bats or quirts (less than 36" in length)

### **English Tack Specifications:**

#### 1. Bits, Bridles and Nosebands

There is no restriction on bits, bridles and nosebands. Any bit used in Pony Club should enable the Pony Club member to ride safely and to effect control without causing pain or injury to the mount. All bits must be properly fitted and consistent with its intended use. The misuse of any bit may be severely penalized by elimination, up to and including disqualification.

#### 2. Reins

A single set of reins which are connected and have a snap or leather breakaway feature on both sides.

#### 3. Saddles

Any english saddle with a tree.

### **NOT Permitted**

Bareback pads, jockey saddles, sidesaddles.

### **Extra Equipment**

#### **Permitted**

A breastplate/breast collar is recommended.

Crupper, running martingale (with rein stops), standing martingale, tie down (noseband must be made entirely of flat leather)

Seat savers

Bell boots of any color

Boots/wraps of any color,

Whip, bats or quirts (less than 36" in length)

## **Article 38—Competitor and Horse Inspections**

Mounts must be well groomed. Manes may be braided or banded and tails may be braided, as long as it does not interfere with the competitor's responsibilities to his/her mount. Braids/bands must be removed prior to Turnback. Mounts need not be shod, but their feet are expected to be in good condition and not in need of any attention upon arrival at the rally. The ground jury may exclude unsafe, inappropriate, lame, otherwise unsound or exhausted mounts from the competition at any time during the rally.

### **Examinations of Horse and Rider Required at Gymkhana Rally:**

#### 1. Horse Inspections (Jog Outs):

Horse inspections are required at standard rallies and Championships and recommended for all rallies. Before the beginning of competition, the mounts must be examined for soundness in hand, by an inspection panel. All mounts shall be serviceably sound. Should the soundness of a mount be questioned, the matter shall be reported immediately to the TD, who shall request an inspection of the mount by the veterinarian. In the absence of the veterinarian, the judges or TD shall determine the ability of the mount to compete. All decisions by the veterinarian, TD or judges regarding the soundness of a mount and its ability to compete are final.

## SECTION III: Competition

### Article 39—Competition Format

USPC Gymkhana rallies are competitions where teams compete against each in timed races and horse management competition.

Organizers of competitions are free to select from the types of races (see Section III, Chapter 3). Standard regional rallies must include a minimum of 4 and a maximum of 12 races per day.

### Article 40—Competition Schedule

The following is a general schedule.

1. Briefing—Competitors are responsible for knowing all information from all official briefings whether present or absent. At least one representative from each team must be present at every official briefing.
2. Horse Inspection (formerly jog out)—required at standard rallies and recommended at all rallies. Opportunity to inspect mounts for soundness.
3. Turnout Inspection—Each rider reports at the assigned time and location for the turnout inspection with the mount. Riders must present for turnout inspection in the exact attire and with all the equipment they will wear/use in the first riding phase of the competition
4. First Competition Race (and subsequent races)—The secretary shall make up the race order of go (OOG). The competitors will follow the order of go or risk elimination. The order of go will be available at the beginning of the rally and changes to the order of go may be made for subsequent races.
5. Safety Check—One or more subsequent races of competition may occur on the same or later days. Prior to each additional race, a complete safety check of each competitor's attire, mount, and equipment must take place. A safety check will not be required when races are run back to back.
6. Turnback—Following all races, there may be an official check (turnback) of the mount, tack and equipment used for that phase.
7. Awards

## Chapter 1—Arenas and Equipment

### Article 41—Arena Specifications

While there is not a specific required arena size, each race pattern included ideal dimensions. If using a smaller or differently shaped arena than the race pattern calls for the races may be sized down, however no pole, barrel or pylon may be set closer than 15 feet to any fence. All measurements must be taken from the center of the pole, barrel or pylon.

It is required that the start/finish area be a minimum of 30 feet in length.

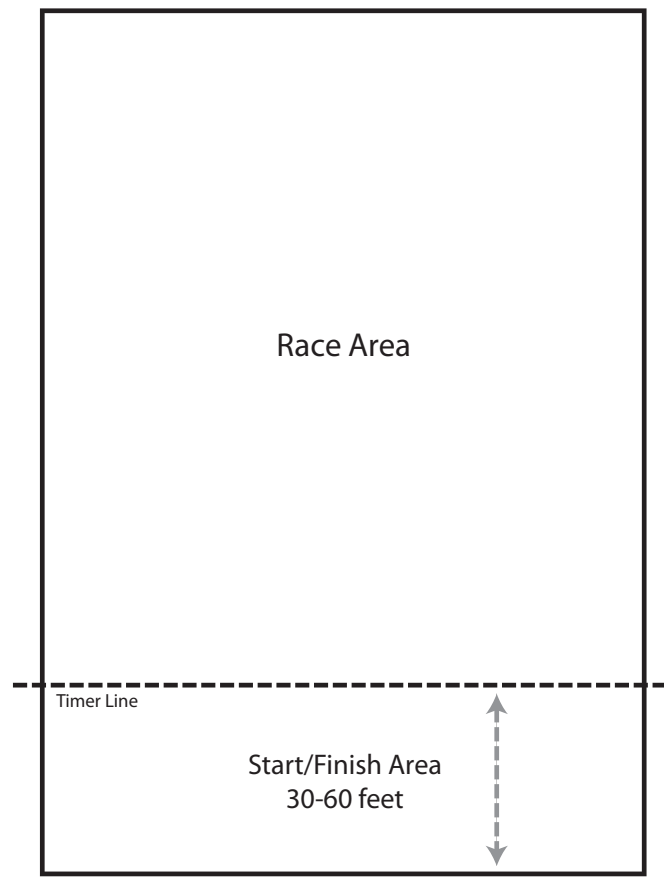

### Article 42—Warm Up Area

A warm-up area must be provided. The warm-up area does not include any practice equipment and should be near, but not necessarily next to, the competition arena. It does not have to be enclosed.

In cases where there is limited space for schooling/warm-up. The number of mounts allowed to warm-up at one time may be restricted by rally organizers.

### Article 43 —Race Equipment

1. Barrels
  - A. Large Barrels: Plastic 50 to 55-gallon barrels are recommended. They should be unweighted. Metal barrels are strongly discouraged, but if used should have protective rubber covering the rim of the barrel.
  - B. Small Barrels: 14" in diameter and 27" high
2. Baseball: In good condition with no loose stitching. Softballs are unacceptable.
3. Flags: 14"-24" dowel rod which is 1/2"-7/8" in diameter; both ends are sharpened to a dull point. The flag shall be affixed to the dowel in the middle. Each flag shall be a different color. The length of the flag sticks should be 12" to 16" above the edge of the bucket used.

# SECTION III: Competition

- Golf Ball: white, in good condition
- Jumps: Standard jump poles between 5'-10' in length made of wood or plastic. White in color. May use jump standards or plastic jump blocks to support poles. If not using a traditional jump standard than it is recommended that poles be placed on each side. May set as a cross rail or straight bar. Jump may be no taller than 18".
- Poles: must be 1" to 1-1/2" in diameter and 54" to 85" tall. All poles must be made of material that will not splinter. Pole bases, weighing 10 to 20 pounds, should be approximately 14" across, and made of black rubber. Containers filled with concrete are NOT allowed.
- Potatoes: Small to medium real whole potatoes
- Pylons: Highway type pylons (Saf-T-Cones), 18" to 28" in height. Should be orange in color. The center of the pylon has a maximum base size of seventeen 17", and weigh a maximum of twelve (12) pounds.
- Sand Bucket: Bucket should be 10 quart rubber or plastic with handle removed filled 3/4 full of sand or soil. A 3-pound coffee can filled 3/4 full of sand or soil, or a 5-gallon bucket with handle removed filled 1/2 full of sand or soil are also acceptable.
- Speedball cone: made of a large pylon with the top cut down to a 5" diameter opening. The cone must be painted white with contrasting stripes top and bottom, and measure an overall height of 24"

## Chapter 2—Rules Governing the Races

### Article 44—General

Riders must remain mounted at all times during each race. Failure to remain mounted will result in eliminations.

### Article 45—Starting and Finishing

Competitors must enter the arena mounted, under control, and in a safe manner at a walk or trot. If a competitor requires assistance to enter an arena they may only receive assistance from their coach or a mounted competitor. Failure to enter the arena, demonstrate control of mount and acknowledging the judge within 2 minutes of being called results in elimination.

Once control of mount is established the competitor must acknowledge the judge. At that point the judge indicate the start of the race with either a white flag, loud verbal cue or other indication. Failure to cross the start line within 1 minute after the chief judge's signal results in elimination. The gate must be closed before the rider starts the pattern or before starting forward motion.

Riders must exit the arena under control at the walk or trot. Exiting the arena may be done mounted or unmounted.

## Chapter 3—Types of Races

### Article 46—Races

#### BARREL BENDING OR BENDING POLES

##### Equipment:

5 large barrels or 5 poles

**Pattern:** Rider will cross timer line, pass the first pole/barrel on either side, pass the successive poles/barrel on alternate sides, turn the last pole and return, passing each pole on alternate sides., and run back across timer line.

Rider may run either right or left hand pattern.

**Penalties:** Five (5) second penalty added for each barrel or pole knocked over.

**Elimination:** Failure to complete pattern, breaking the pattern, crossing back over the starting line before completing the pattern, dismounting, fall of mount or ride

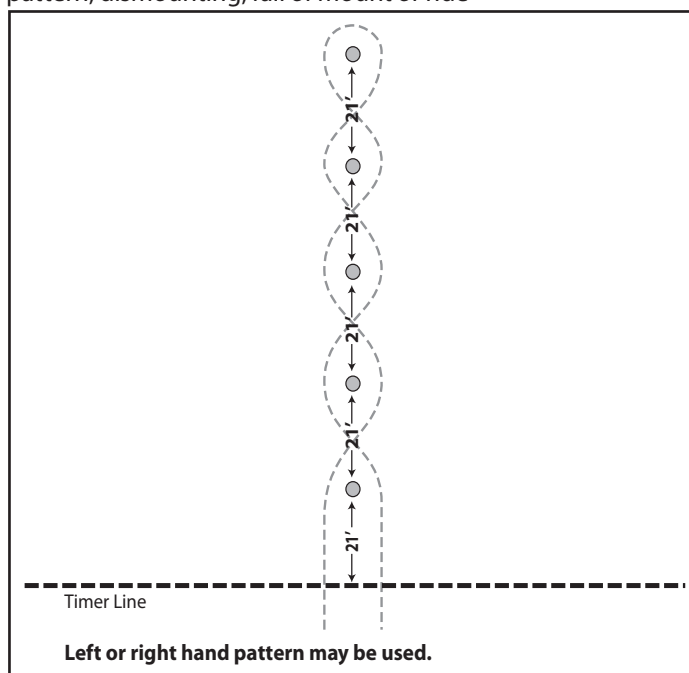

#### BARRELS

##### Equipment:

3 large barrels

**Pattern:** Rider will cross timer line, make 270 degree turn around the first barrel, go to second barrel make 270 degree turn around barrel, go to third barrel make a 270 degree turn around barrel, and run back across timer line.

Rider may run either right or left hand pattern.

**Penalties:** Five (5) second penalty added for each barrel knocked over.

**Elimination:** Failure to complete pattern, breaking the pattern, crossing back over the starting line before completing the pattern, dismounting, fall of mount or rider.

# SECTION III: Competition

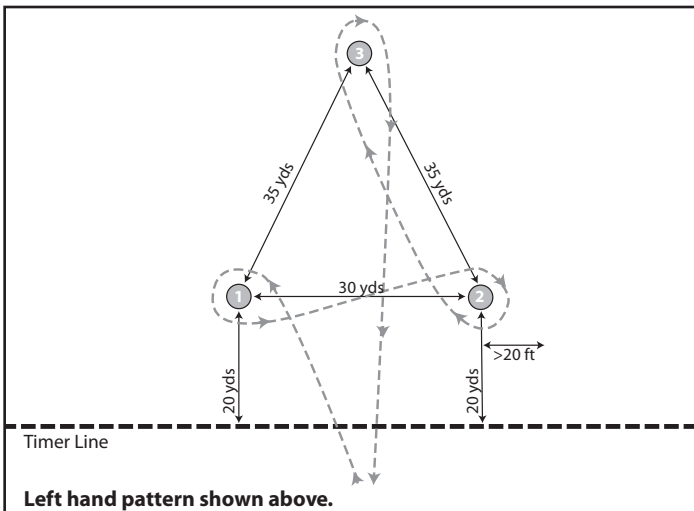
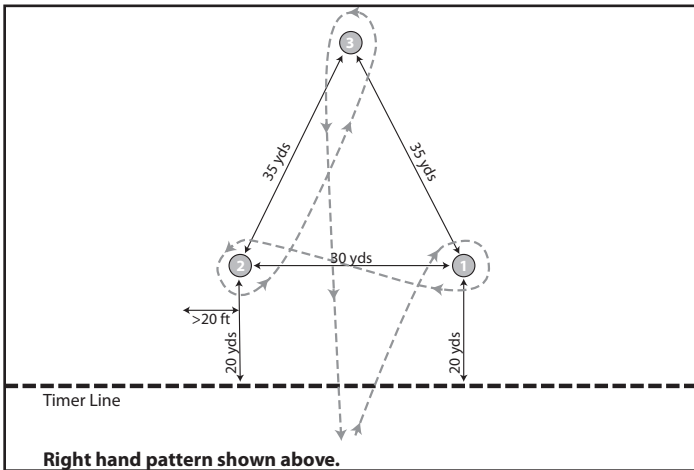

## BASEBALL RACE OR GOLFETTE RACE

### Equipment:

- 2 large barrels (1 with open end)
- 1 sand filled bucket
- 1 baseball or golf ball

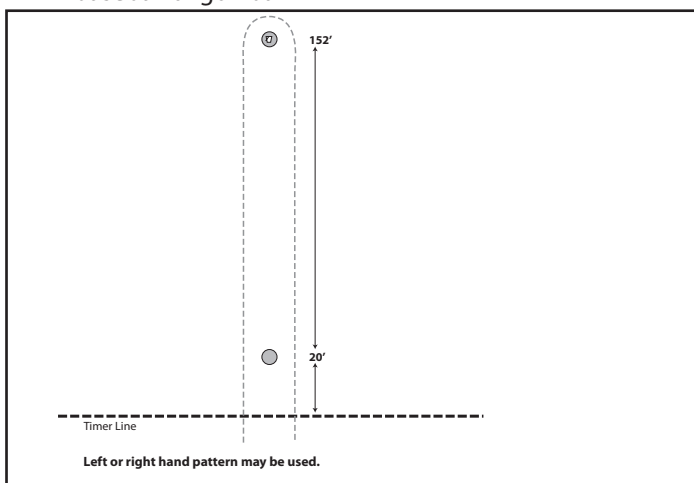

**Pattern:** Rider will cross timer line, make 180 degree turn around the far barrel and pick up ball out of bucket, go to second barrel

and place ball into the open end barrel, and run back across timer line. Rider may run either right or left hand pattern.

**Penalties:** None

**Elimination:** Failure to complete pattern, breaking the pattern, failure to pick up the ball, dropping the ball, ball touching barrel or ground due to actions of mount or rider, failure to deposit ball in goal barrel, failure to compete race, knocking over barrel & ball not in barrel upon completion of ride, crossing back over the starting line before completing the pattern, dismounting, fall of mount or rider.

## BEND AND JUMP

### Equipment:

- 3 poles
- 1 large barrel
- 1 jump

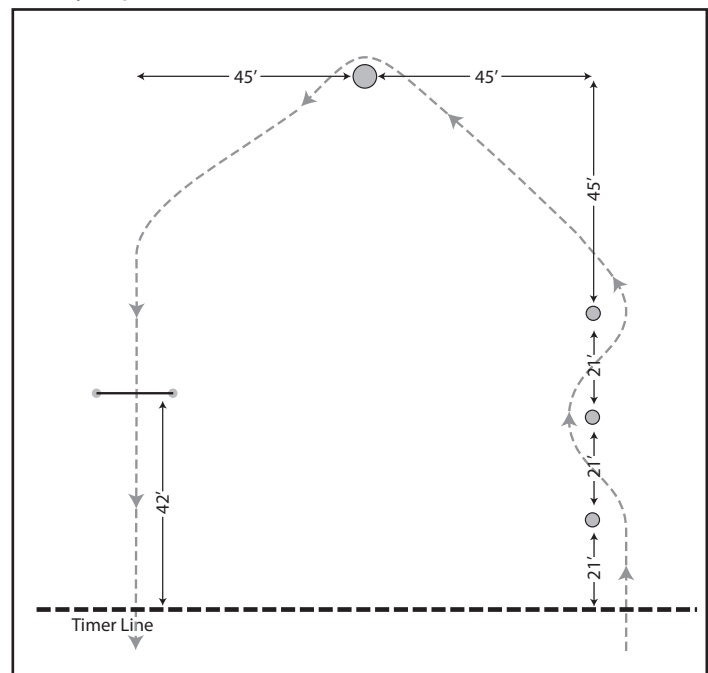

**Pattern:** Rider will cross timer line, weave through poles starting on right side, go around back side of barrel and then go over jump while heading back toward timer line, and run back across timer line. Rider must start on the right hand side.

**Penalties:** Five (5) second penalty added for each barrel, pole or jump knocked over.

**Elimination:** Failure to complete pattern, breaking the pattern, failure to have all four feet of the mount go over each jump, crossing back over the starting line before completing the pattern, dismounting, fall of mount or rider.

# SECTION III: Competition

## BIG M RACE

### Equipment:

3 large barrels

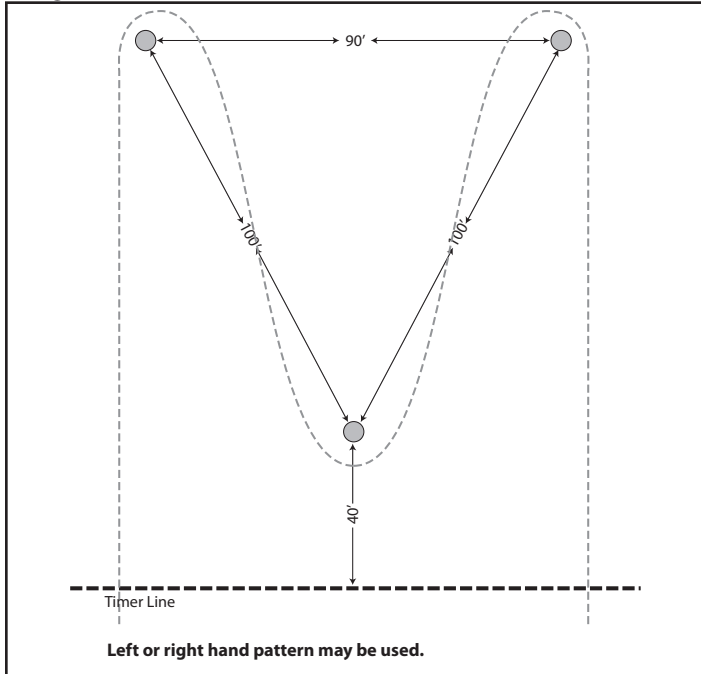

**Pattern:** Rider will cross timer line, go around back side of far end barrel, than go around front side of near barrel, than go around the back side of far end barrel and run back across timer line. Pattern will make an "M". Rider may run either right or left hand pattern.

**Penalties:** Five (5) second penalty added for each barrel knocked over.

**Elimination:** Failure to complete pattern, breaking the pattern, crossing back over the starting line before completing the pattern, dismounting, fall of mount or rider.

## BIG O RACE

### Equipment:

2 large barrels

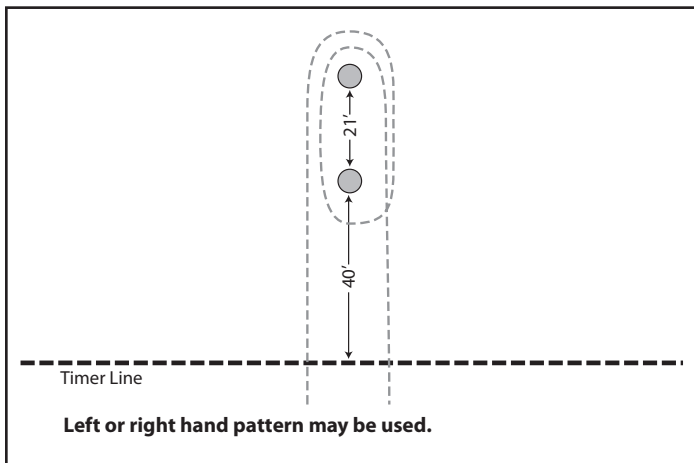

**Pattern:** Rider will cross timer line, turn around the far barrel, go to the near barrel turn around it and go back to far barrel and turn around it, and run back across timer line. Rider may run either right or left hand pattern.

**Penalties:** Five (5) second penalty added for each barrel knocked over.

**Elimination:** Failure to complete pattern, breaking the pattern, crossing back over the starting line before completing the pattern, dismounting, fall of mount or rider.

## BIG T RACE

### Equipment:

2 large barrels

3 poles

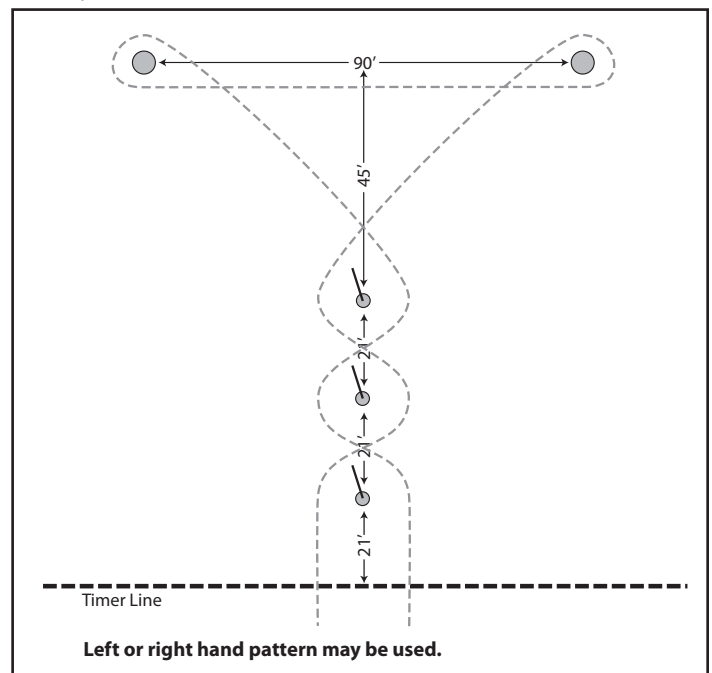

**Pattern:** Rider will cross timer line passing Pole 1 and then weaves poles 2 and 3. After passing pole 3 the rider continues toward the inside of barrel 1, executes a turn-around barrel 1, and then continues in a straight line to barrel 2. The rider executes the same turn around barrel 2 and then proceeds to the opposite side of pole 3. The rider weaves back through the poles until they cross the timer line. Rider may run either right or left hand pattern.

**Penalties:** Five (5) second penalty added for each barrel knocked over.

**Elimination:** Failure to complete pattern, breaking the pattern, crossing back over the starting line before completing the pattern, dismounting, fall of mount or rider.

# SECTION III: Competition

## BIG Z RACE

### Equipment:

- 4 large barrels
- 2 poles

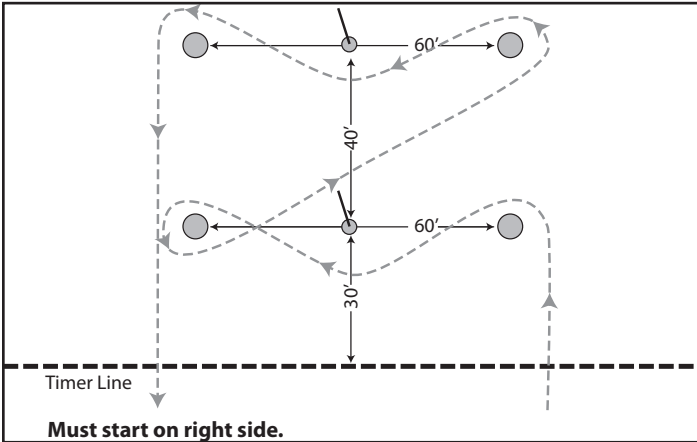

**Pattern:** Rider will cross timer line, go around the back side of the near right side barrel, weave around the pole passing in front of it, weave around the left side near barrel passing on the back side making a 270 degree turn around it and proceed to the right side far barrel, go around the back of that barrel and weave around the pole passing in front of it and passing around the back of the left side far barrel, turn the barrel and run back across timer line. Pattern will make a "Z."

Rider must start on right side of pattern.

**Penalties:** Five (5) second penalty added for each barrel or pole knocked over.

**Elimination:** Failure to complete pattern, breaking the pattern, crossing back over the starting line before completing the pattern, dismounting, fall of mount or rider.

## BIRANGLE RACE

### Equipment:

- 2 large barrels

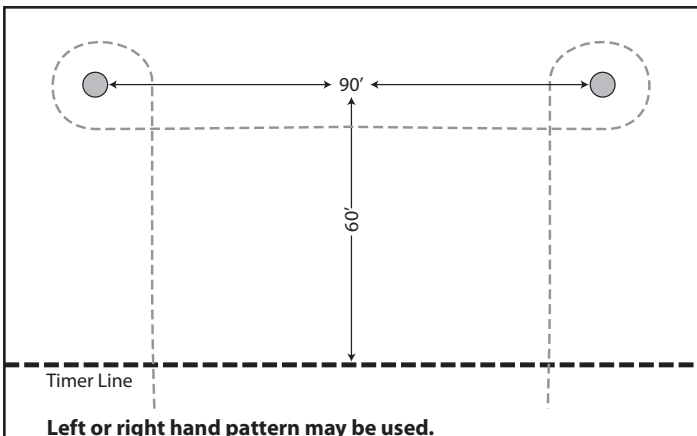

**Pattern:** Go through the timing line and run to the inside of either barrel. Turn the barrel and run to the second barrel, turning in the same direction as the first barrel. Return to timer line. Rider may run either right or left hand pattern.

**Penalties:** Five (5) second penalty added for each barrel knocked over.

**Elimination:** Failure to complete pattern, breaking the pattern, crossing back over the starting line before completing the pattern, dismounting, fall of mount or rider.

## BOOT LACE RACE

### Equipment:

- 1 large barrel
- 10 poles

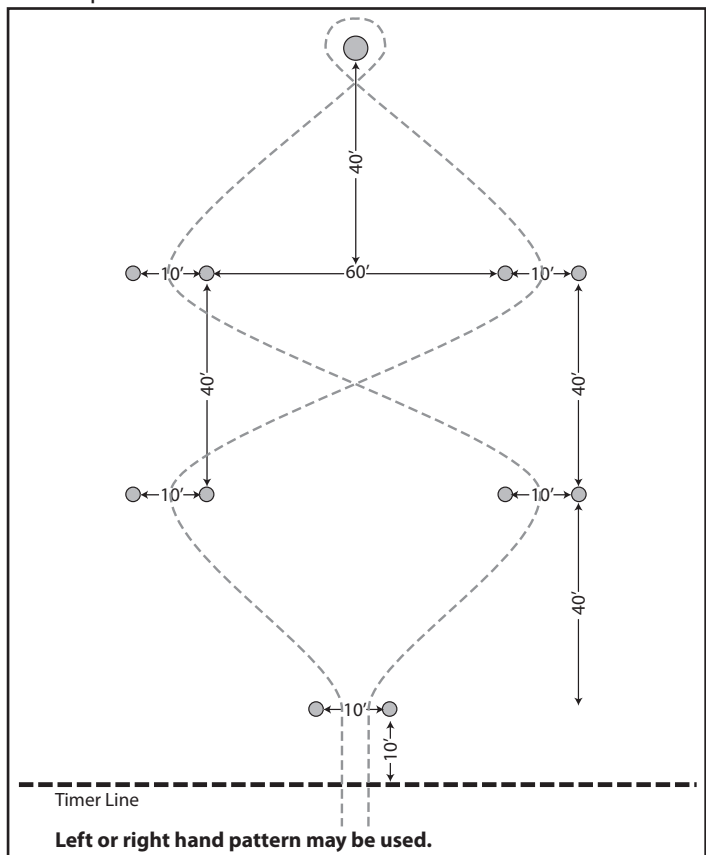

**Pattern:** Rider will cross timer line, pass between poles at timer line, pass between middle poles on one side, angle across arena and pass through far poles, angle across arena make a 270 degree turn around barrel and pass through far poles that have not been passed through yet, angle across arena and pass through middle poles that have not been passed through yet, pass through poles at timer line and cross timer line. Rider may run either right or left hand pattern.

**Penalties:** Five (5) second penalty added for each barrel or pole knocked over.

# SECTION III: Competition

**Elimination:** Failure to complete pattern, breaking the pattern, failure to pass between poles, crossing back over the starting line before completing the pattern, dismounting, fall of mount or rider.

## BOW TIE RACE

### Equipment:

5 cones

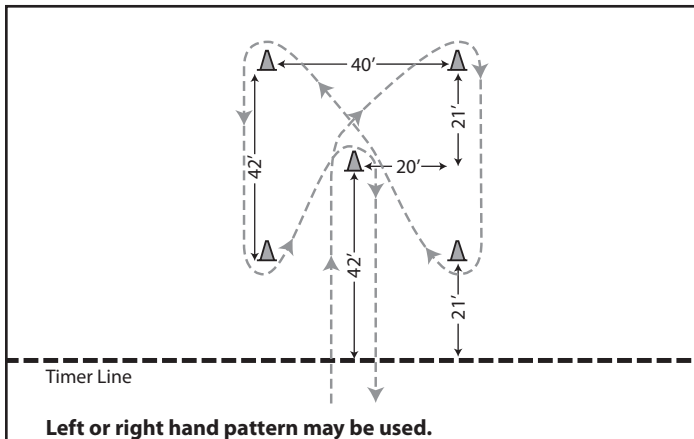

**Pattern:** Rider will cross timer line proceeds to the left of the center cone and then tracks right, around the right side top and bottom cones. Continue a diagonal path to the left top cone by staying to the right of the center cone and track left around the left side top and bottom cones. Finish by turning around the center cone tracking right and running back across timer line. Rider may run either right or left hand pattern.

**Penalties:** None

**Elimination:** Failure to complete pattern, breaking the pattern, or knocking over or straddling a cone, crossing back over the starting line before completing the pattern, dismounting, fall of mount or rider.

## BULGE RACE

### Equipment:

2 large barrels

4 poles

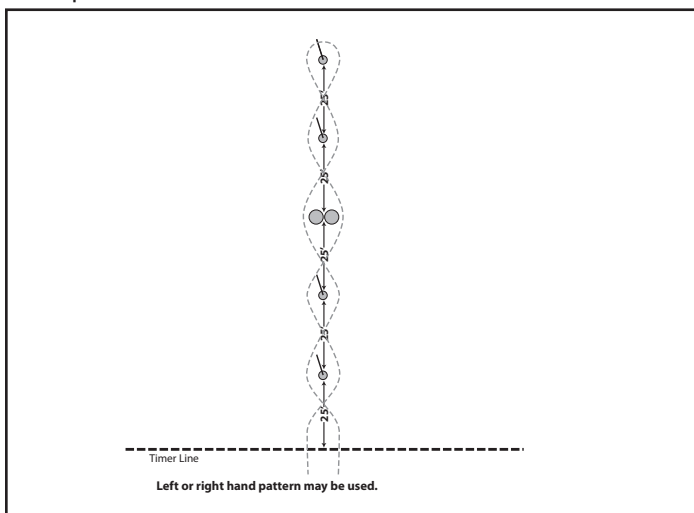

**Pattern:** Rider will cross timer line, weave around first 2 poles, barrels, and last 2 poles, make a 270 degree turn around last pole and proceed to weave poles, barrels and poles before crossing timer line. Rider may run either right or left hand pattern.

**Penalties:** Five (5) second penalty added for each barrel or pole knocked over.

**Elimination:** Failure to complete pattern, breaking the pattern, crossing back over the starting line before completing the pattern, dismounting, fall of mount or rider.

## BUTTERFLY RACE

### Equipment:

6 poles

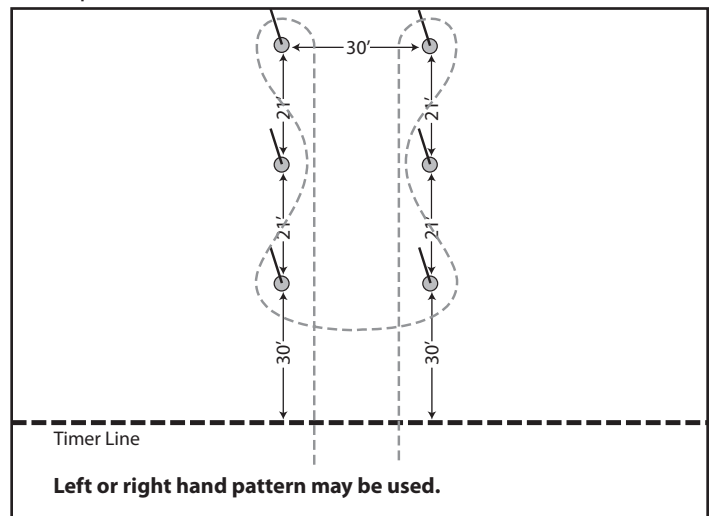

**Pattern:** Rider will cross timer line, run up the middle of poles, turn around back of one side of the poles, weaves through them, crosses straight across the front of the arena, weaves through poles up the other side of the arena, turns around end pole and runs back down the middle of the poles and across timer line. Rider may run either right or left hand pattern.

**Penalties:** Five (5) second penalty added for each pole knocked over.

**Elimination:** Failure to complete pattern, breaking the pattern, crossing back over the starting line before completing the pattern, dismounting, fall of mount or rider.

## CANDLE RACE

### Equipment:

1 large barrel

3 poles

**Pattern:** Rider will cross timer line, weaves up through poles and barrel, make 270 degree turn around barrel weaving the poles back to timer line and back across timer line. Rider may run either right or left hand pattern.

# SECTION III: Competition

**Penalties:** Five (5) second penalty added for each barrel or pole knocked over.

**Elimination:** Failure to complete pattern, breaking the pattern, crossing back over the starting line before completing the pattern, dismounting, fall of mount or rider.

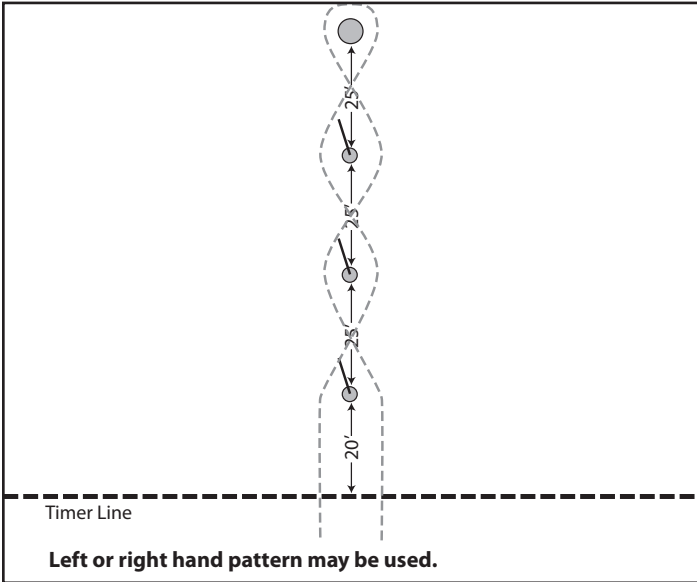

pattern, dismounting, fall of mount or rider.

## CAT'S CRADLE RACE\* (AKA DIAMOND RACE)

**Equipment:**  
4 large barrels

*\*use pattern dimensions that is most appropriate to arena size*

**Pattern:** Rider will cross timer line, passes on the outside of the near barrel, proceeds across arena and around the far side of middle barrel, proceeds across arena and makes a 270 degree turn around barrel, proceeds across arena and passes around far side of middle barrel, proceed across arena and pass on far side of near barrel and run back across timer line. Rider may run either right or left hand pattern.

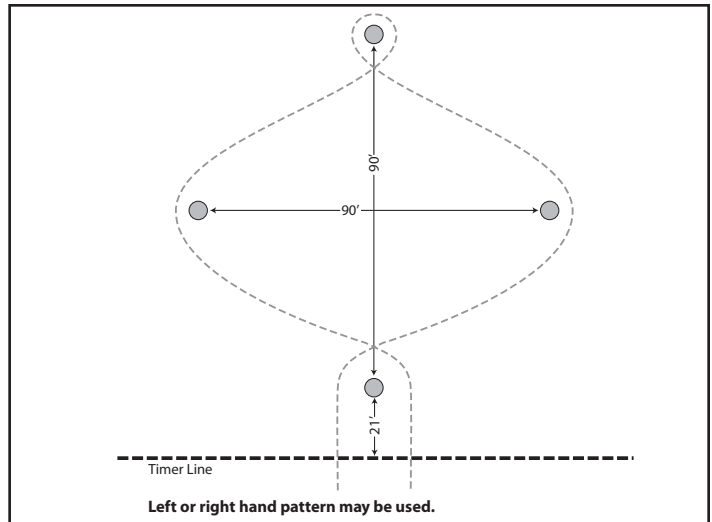
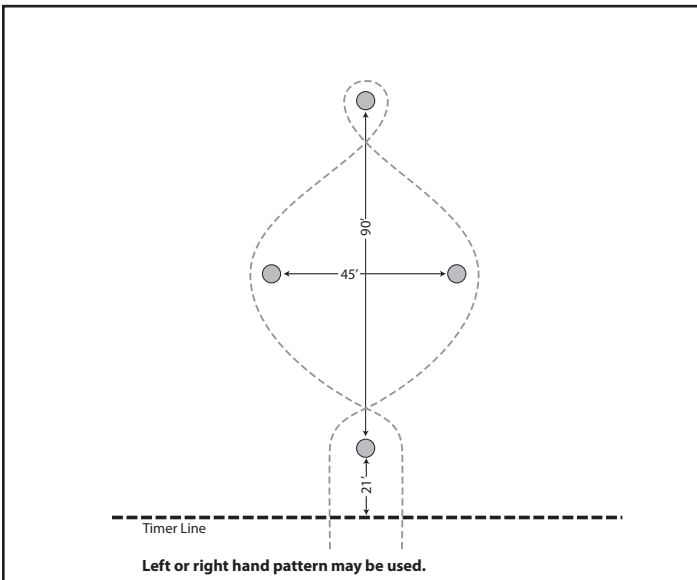

**Penalties:** Five (5) second penalty added for each barrel knocked over.

**Elimination:** Failure to complete pattern, breaking the pattern, crossing back over the starting line before completing the pattern, dismounting, fall of mount or rider.

## CRAZY 8 RACE

**Equipment:**  
2 large barrels

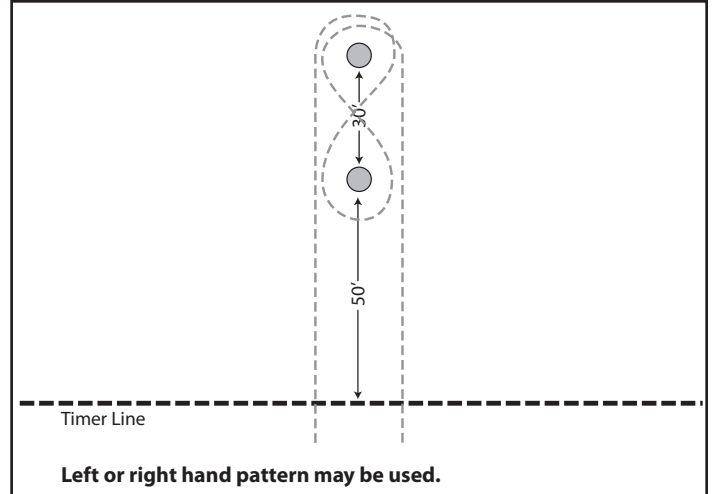

**Pattern:** Rider will cross timer line, run to far barrel, turn around barrel, proceed to near barrel and turn opposite way around barrel, proceed back to far barrel and turn opposite way (making a figure 8), and run back across timer line. Rider may run either right or left hand pattern.

**Penalties:** Five (5) second penalty added for each barrel knocked over.

**Elimination:** Failure to complete pattern, breaking the pattern, crossing back over the starting line before completing the pattern, dismounting, fall of mount or rider.



# SECTION III: Competition

## CRAZY TRIANGLE

**Equipment:**  
3 poles

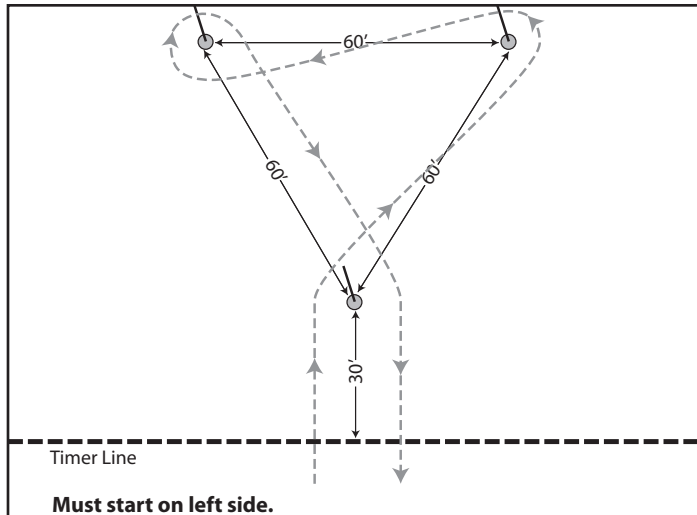

**Pattern:** Rider will cross timer line, passes on left side of middle pole, proceeds to right pole and turn left around it, proceed to left side pole and turn right around pole, proceed back to timer line passing on right side of middle pole. Rider must start on left side.

**Penalties:** Five (5) second penalty added for each pole knocked over.

**Elimination:** Failure to complete pattern, breaking the pattern, crossing back over the starting line before completing the pattern, dismounting, fall of mount or rider.

## CUPID'S ARROW RACE

**Equipment:**  
3 large barrels and 4 poles

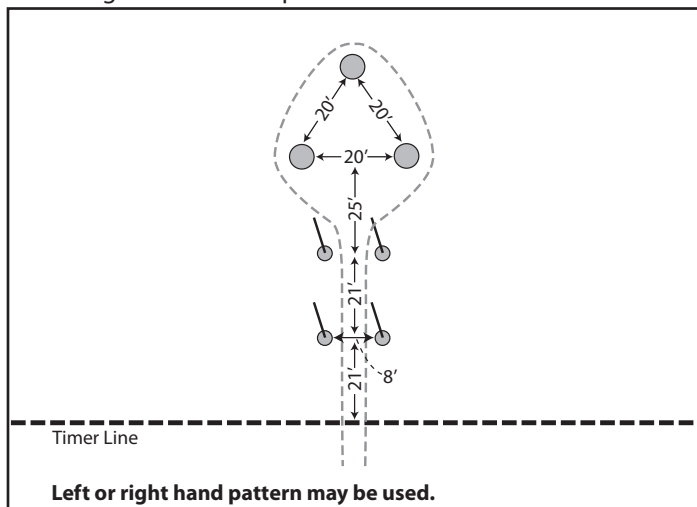

**Pattern:** Rider will cross timer line, run up middle of poles, make circle around all barrels and run back between poles, and back across timer line. Rider may run either right or left hand pattern.

**Penalties:** Five (5) second penalty added for each barrel or pole knocked over.

**Elimination:** Failure to complete pattern, breaking the pattern, crossing back over the starting line before completing the pattern, dismounting, fall of mount or rider.

## DOUBLE BOWTIE

**Equipment:**  
3 large barrels

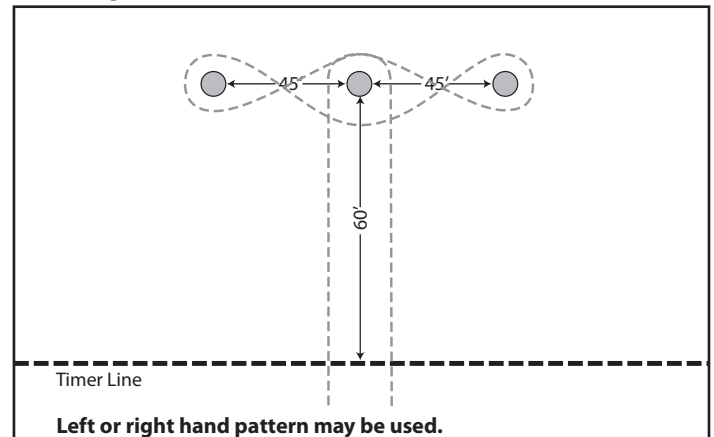

**Pattern:** Rider will cross timer line, turn around middle barrel to the right, go to right barrel and turn around it to the left, pass on left side of middle barrel, go to far left barrel and turn left around it, proceed back to middle barrel and turn right around, and run back across timer line. Rider may run either right or left hand pattern.

**Penalties:** Five (5) second penalty added for each barrel knocked over.

**Elimination:** Failure to complete pattern, breaking the pattern, crossing back over the starting line before completing the pattern, dismounting, fall of mount or rider.

## FIGURE 8 BARREL COWHORSE RACE OR FIGURE 8 POLE COWHORSE RACE

**Equipment:**  
2 small barrels and 1 large barrel  
or 2 poles and 1 large pole

**Pattern:** (See pattern illustration top of next page). Rider will cross timer line, passes on right side of first small barrel/pole, than turn right around far barrel/pole than turn left around first barrel/pole, proceed across arena and turn right around the back side of the large barrel and run back across timer line. Rider must start on left hand side.

**Penalties:** Five (5) second penalty added for each barrel or pole knocked over.

# SECTION III: Competition

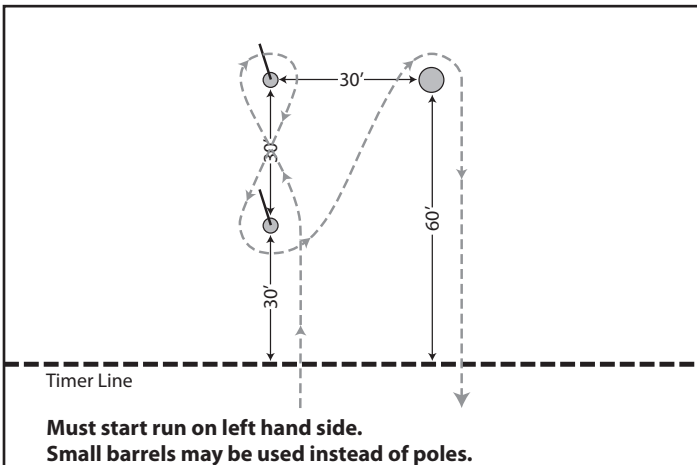

**Elimination:** Failure to complete pattern, breaking the pattern, crossing back over the starting line before completing the pattern, dismounting, fall of mount or rider.

## FIGURE 8 RACE

**Equipment:**  
2 poles

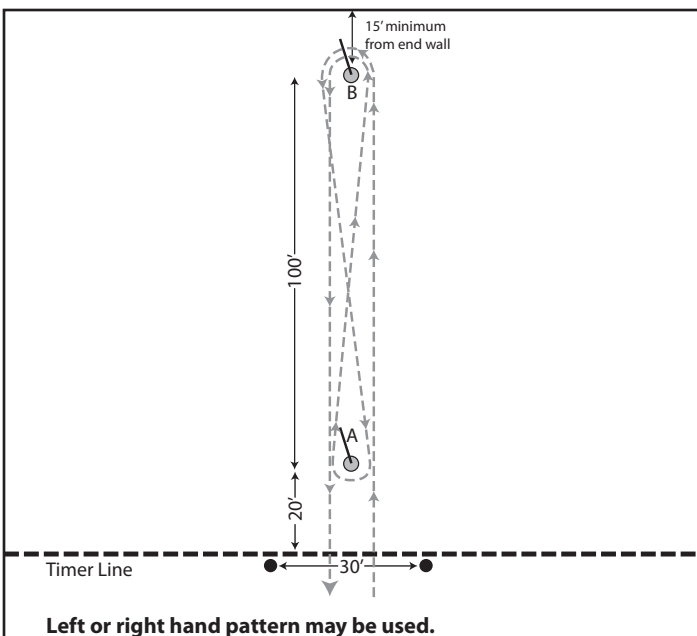

**Pattern:** Ride crosses timer line and rides down the side of the course (side optional) to pole B, turns pole B, rides to pole A, turns pole A in the opposite direction, rides back to pole B, turns pole B in the opposite direction of A, and rides across the finish line, completing a figure 8 pattern and runs back across timer line. Rider may run either right or left hand pattern.

**Penalties:** Five (5) second penalty added for each pole knocked over.

**Elimination:** Failure to complete pattern, breaking the pattern, crossing back over the starting line before completing the pattern, dismounting, fall of mount or rider.

## FLYING W RACE

**Equipment:**  
5 poles

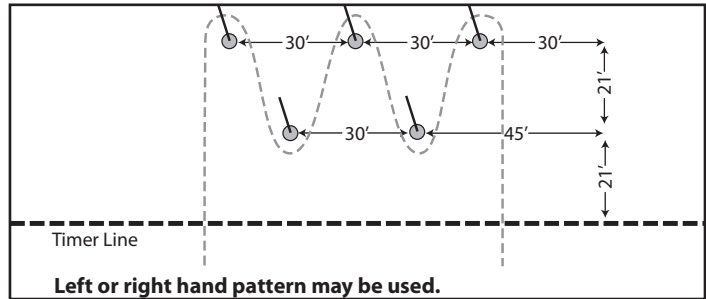

**Pattern:** Rider will cross timer line on the side corresponding to either the left most or right most pole and turn around the back of the pole. Weave through poles diagonally. Turn last pole and returns crossing the timer line. Rider may run either right or left hand pattern.

**Penalties:** Five (5) second penalty added for each pole knocked over.

**Elimination:** Failure to complete pattern. Breaking the pattern. Crossing back over the starting line before completing the pattern, dismounting, fall of mount or rider.

## FOUR FLAG RACE

**Equipment:**  
1 large barrel  
4 flags  
4 sand buckets.

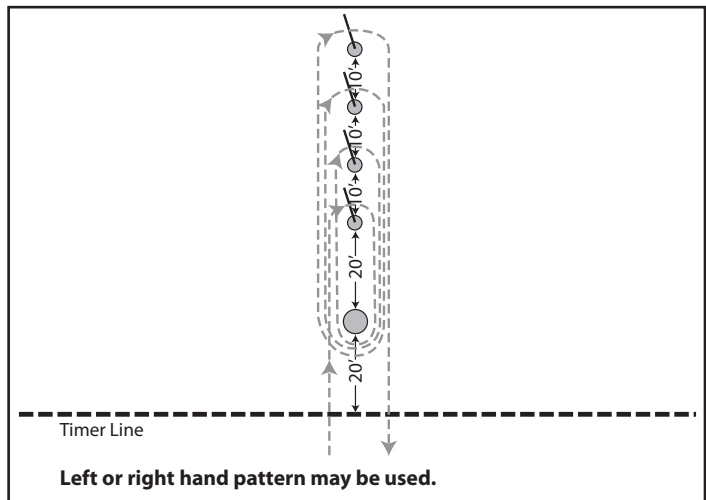

**Pattern:** A rider crosses the line and runs to FIRST flag OR FOURTH flag, picks it up, returns to barrel and drops flag in barrel and continues consecutively up (1, 2, 3, 4) OR down (4, 3, 2, 1) the row of flags. After the last flag is deposited, cross the finish line. A rider may start on either side of the flags but must continue picking flags from the same side throughout. Rider may run either right or left hand pattern.

# SECTION III: Competition

**Penalties:** Five (5) second penalty added for each barrel knocked over.

**Elimination:** Failure to complete pattern, breaking the pattern, not picking flags in proper order either: 4, 3, 2, 1 or 1, 2, 3, 4, touching mount with flag (that is: used as a crop), dropping or missing a flag, crossing back over the starting line before completing the pattern, dismounting, fall of mount or rider.

## FOUR LEAF CLOVER BARREL RACE

### Equipment:

4 large barrels

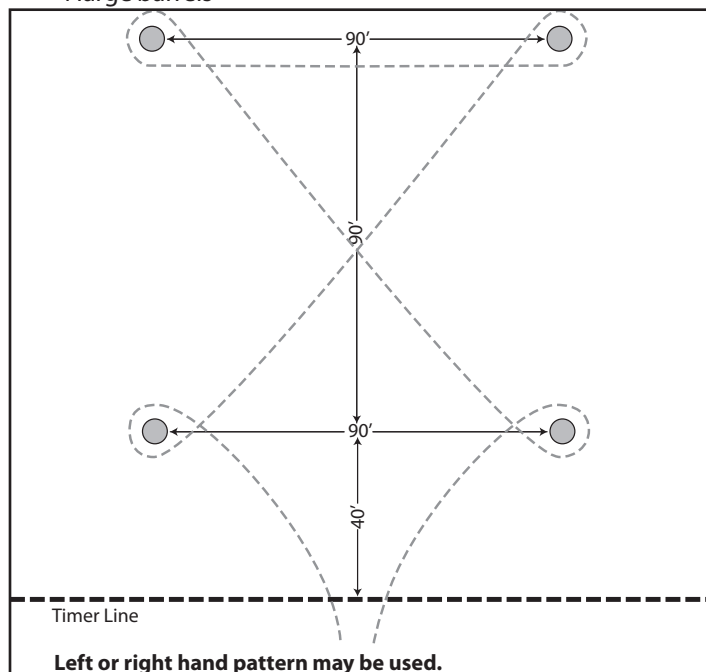

**Pattern:** Rider will cross timer line, make 270 degree turn around the first barrel, go to second barrel make 270 degree turn around barrel, go straight across arena to third barrel make a 270 degree turn around barrel, go to fourth barrel make a 270 degree turn around barrel and run back across timer line.

Rider may run either right or left hand pattern.

**Penalties:** Five (5) second penalty added for each barrel knocked over.

**Elimination:** Failure to complete pattern. Breaking the pattern. Crossing back over the starting line before completing the pattern, dismounting, fall of mount or rider.

## HITCH AND GO RACE

### Equipment:

4 poles

**Pattern:** Rider crosses timer line going between the first two (2) poles to the next set of poles, either to the right or left pole. Going to the inside of the chosen pole, making a 270 degree turn around the pole, across the arena to the opposite pole and make same

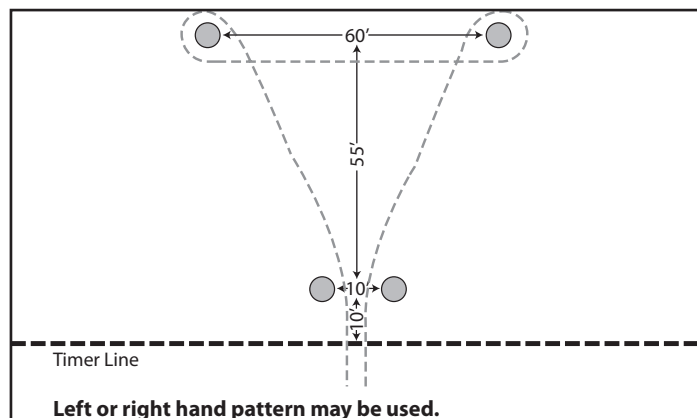

(right/left) 270 degree turn, finishing on the inside of the pole. Completing the pattern by going back through the first two (2) poles and across the timer line.

Rider may run either right or left hand pattern.

**Penalties:** Five (5) second penalty added for each pole knocked over.

**Elimination:** Failure to complete pattern. Breaking the pattern. Crossing back over the starting line before completing the pattern, dismounting, fall of mount or rider.

## HORSESHOE BARREL RACE

### Equipment:

7 large barrels

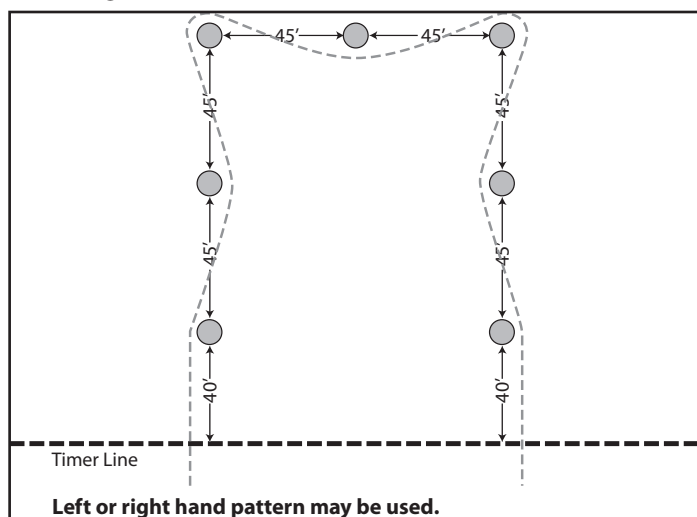

**Pattern:** Rider will cross timer line to the first barrel weaving each barrel, before crossing the timer line. Rider may run either right or left hand pattern.

**Penalties:** Five (5) second penalty added for each barrel knocked over.

**Elimination:** Failure to complete pattern. Breaking the pattern. Crossing back over the starting line before completing the pattern, dismounting, fall of mount or rider.

# SECTION III: Competition

## HOURGLASS RACE

### Equipment:

- 4 large barrels
- 2 small barrels

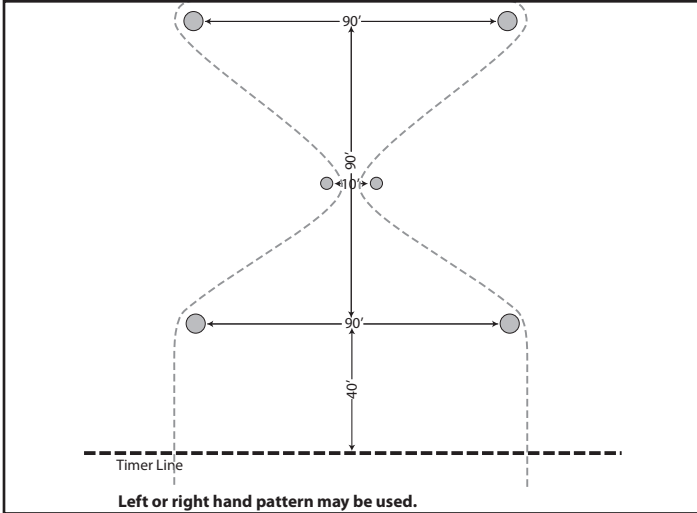

**Pattern:** Rider will cross timer line, passing on the left side of the left side near barrel, will then go between the small barrels turning to the left, go around the left side back barrel to the right, proceed straight across the ring and turn right around the back right barrel, go between the small barrel and turn left, pass on the outside of the right side near barrel and run back across timer line. Rider may run either right or left hand pattern.

**Penalties:** Five (5) second penalty added for each barrel knocked over.

**Elimination:** Failure to complete pattern, breaking the pattern, crossing back over the starting line before completing the pattern, dismounting, fall of mount or rider.

## HURRY SCURRY RACE

### Equipment:

- 1 pole
- 4 jumps

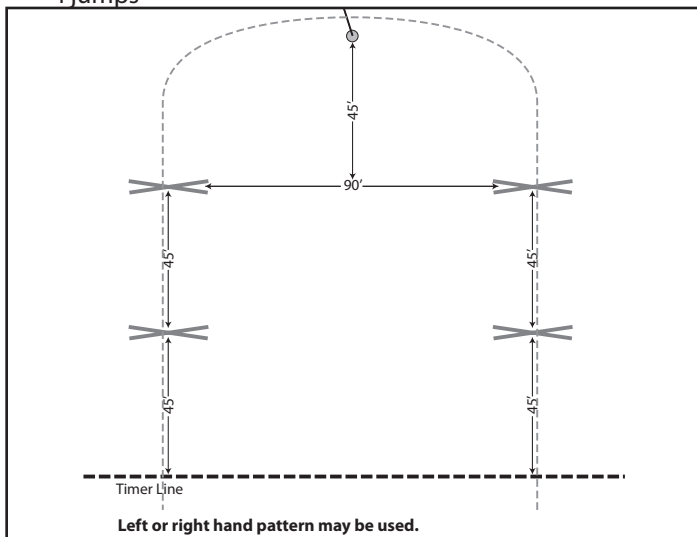

**Pattern:** Go through timing line and either go down left side making two jumps, a right turn around the pole and 1 jump, or go down right side making 1 jump, a left turn around the pole and two jumps, then go back across the timer line.

Rider may run either right or left hand pattern.

**Penalties:** Five (5) second penalty added for each pole or jump knocked over.

**Elimination:** Failure to complete pattern. Breaking the pattern. Failure to have all four feet of the mount go over each jump, Crossing back over the starting line before completing the pattern, dismounting, fall of mount or rider.

## I BEAM RACE

### Equipment:

- 3 large barrels
- 4 poles

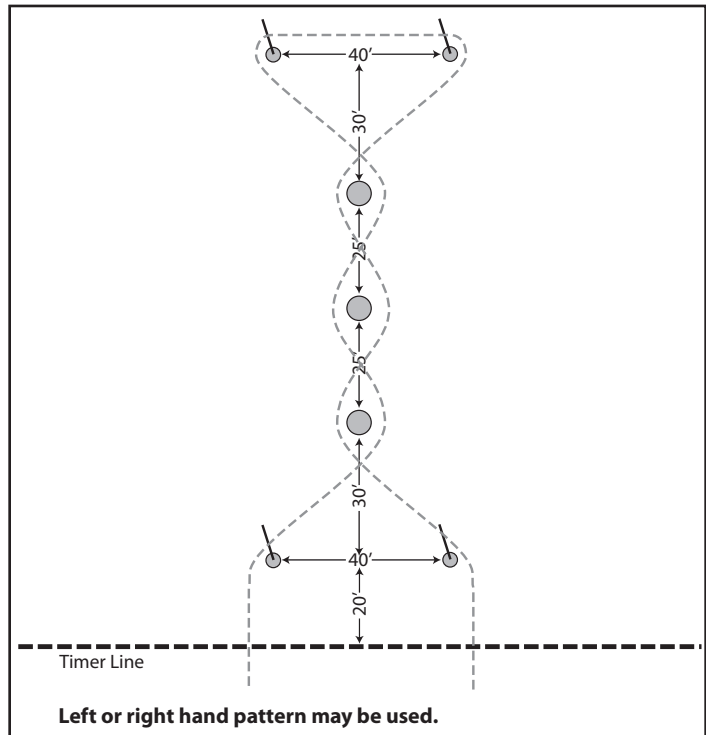

**Pattern:** Rider will cross timer line, pass on the outside of the first pole, weave the barrels, turning a circle around the far poles, weave the barrels back down and pass on the outside of the opposite near pole and run back across timer line.

Rider may run either right or left hand pattern.

**Penalties:** Five (5) second penalty added for each barrel or pole knocked over.

**Elimination:** Failure to complete pattern, breaking the pattern, crossing back over the starting line before completing the pattern, dismounting, fall of mount or rider.

# SECTION III: Competition

## KEY RACE

**Equipment:**  
4 poles

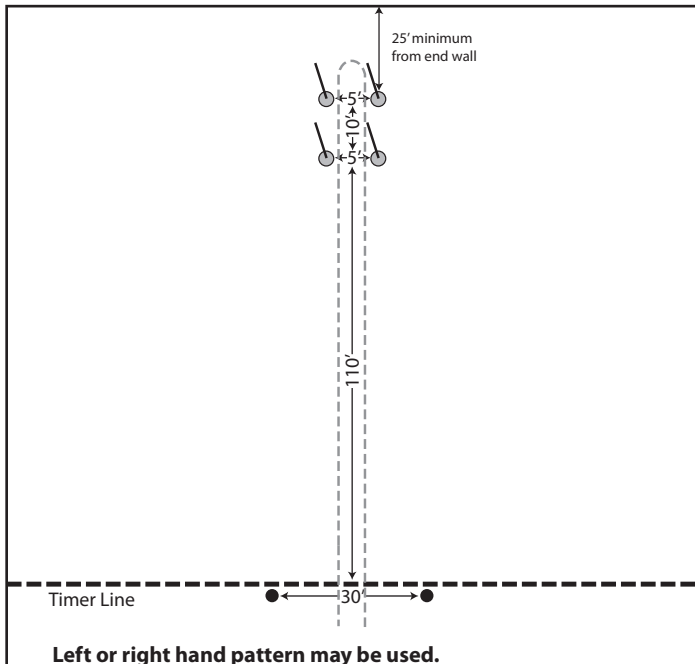

**Pattern:** Rider will cross timer line, passing completely between both sets of poles (as diagrammed), turns, reverses course back between both sets of poles, and run back across timer line. Rider may run either right or left hand pattern.

**Penalties:** Five (5) second penalty added for each pole knocked over.

**Elimination:** Failure to complete pattern, breaking the pattern, crossing back over the starting line before completing the pattern, dismounting, fall of mount or rider.

## KEYHOLE BARREL RACE OR KEYHOLE POLE RACE

**Equipment:**  
4 poles and 1 large barrel  
or 5 poles

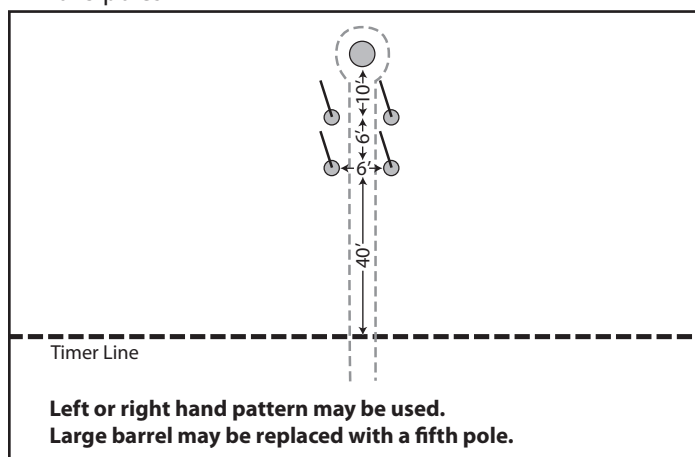

**Pattern:** Rider will cross timer line, go between the first four poles, turn around the 5th pole (in either direction), run back through the four poles and run back across timer line. Rider may run either right or left hand pattern.

**Penalties:** Five (5) second penalty added for each of the first 4 poles knocked over.

**Elimination:** Failure to complete pattern, breaking the pattern, knocking over the barrel or fifth pole, crossing back over the starting line before completing the pattern, dismounting, fall of mount or rider if the mount and rider do not enter the poles through the middle of the first set, the rider may stop the mount, back him up and continue with the pattern as it should be, the rider may not turn the mount and return to where they broke the pattern or they will be eliminated.

## KEYHOLE RACE

**Equipment:**  
Lime, spray paint or chalk in contrasting color to arena footing

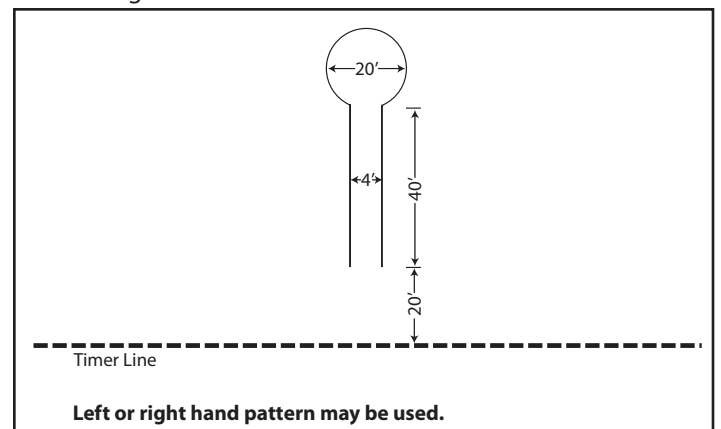

**Pattern:** Rider will cross timer line, running through the slot, turning and running out through the slot and run back across timer line. Rider may run either right or left hand pattern.

**Penalties:** Five (5) second penalty added for each barrel knocked over.

**Elimination:** Failure to complete pattern, breaking the pattern, any hoof of the mount stepping on or crossing over the slot or keyhole, crossing back over the starting line before completing the pattern, dismounting, fall of mount or rider.

## LARRYETTE RACE

**Equipment:**  
1 large barrel  
6 poles

**Pattern:** Rider will cross timer line, and goes on the outside of the first pole, inside of second and outside of the third, and goes around the barrel. Rider then proceeds to the second set of poles going outside the first, inside the second and outside the third, and run back across timer line. Rider may run either right or left hand pattern.

# SECTION III: Competition

**Penalties:** Five (5) second penalty added for each barrel or pole knocked over.

**Elimination:** Failure to complete pattern, breaking the pattern, crossing back over the starting line before completing the pattern, dismounting, fall of mount or rider.

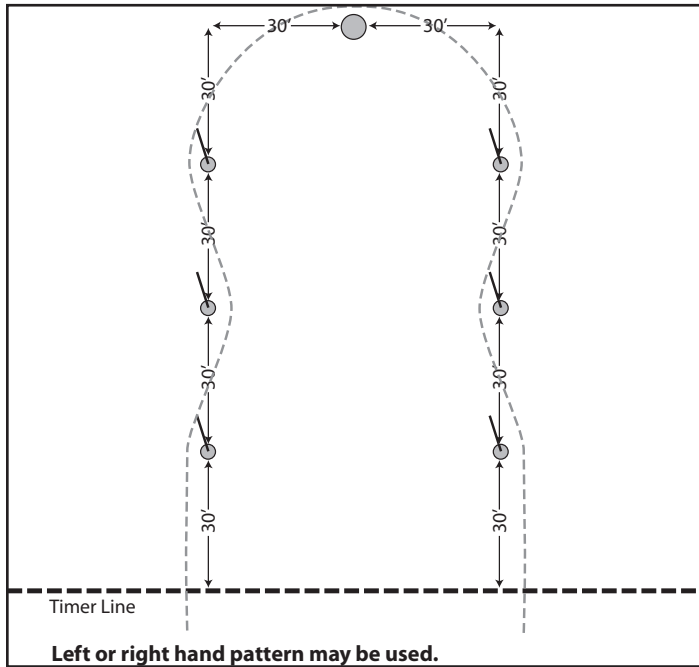

## LONDON BRIDGE RACE

**Equipment:**  
6 poles  
1 jump

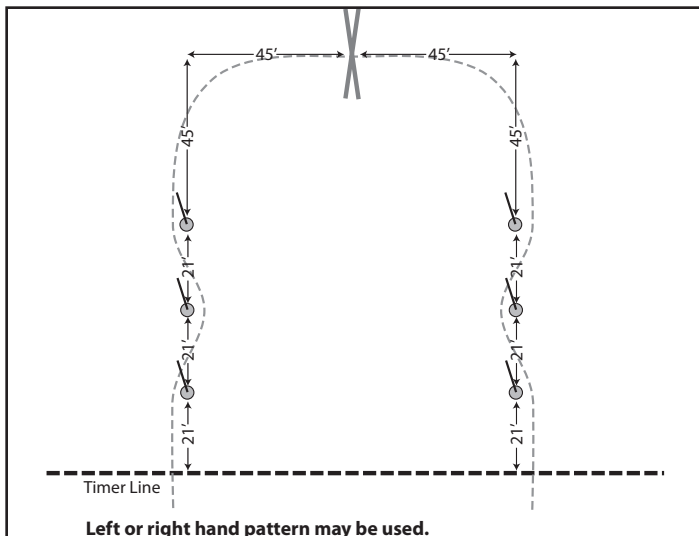

**Pattern:** Rider will cross timer line, weaves the poles up starting on the outside of the first pole, goes over the jump and weaves the opposite side poles passing the last poles on the outside and run back across timer line.

Rider may run either right or left hand pattern.

**Penalties:** Five (5) second penalty added for each pole or jump knocked over.

**Elimination:** Failure to complete pattern. Breaking the pattern. Failure to have all four feet of the mount go over each jump. Crossing back over the starting line before completing the pattern, dismounting, fall of mount or rider.

## MOUNTAIN COWHORSE RACE

**Equipment:**

1 large barrels  
3 poles

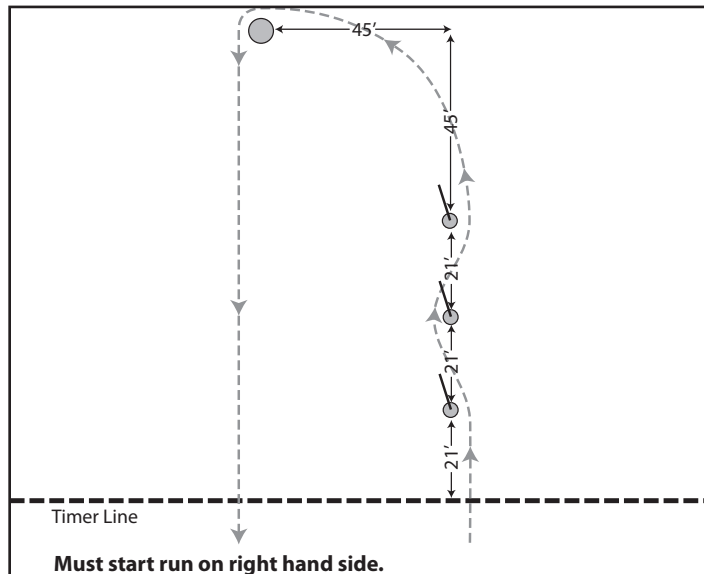

**Pattern:** Rider will cross timer line, weave poles passing the first pole on the outside, **turn on the outside of the barrel**, and run back across timer line. Must start on right hand side.

**Penalties:** Five (5) second penalty added for each barrel or pole knocked over.

**Elimination:** Failure to complete pattern, breaking the pattern, crossing back over the starting line before completing the pattern, dismounting, fall of mount or rider.

## OPEN END FIGURE 8 RACE

**Equipment:**  
2 large barrels

**Pattern:** Rider will cross timer line, pass on outside of first barrel, turn opposite way around second barrel, pass on opposite side of first barrel making a figure 8 and run back across timer line. Rider may run either right or left hand pattern.

**Penalties:** Five (5) second penalty added for each barrel knocked over.

**Elimination:** Failure to complete pattern, breaking the pattern, crossing back over the starting line before completing the pattern, dismounting, fall of mount or rider.

# SECTION III: Competition

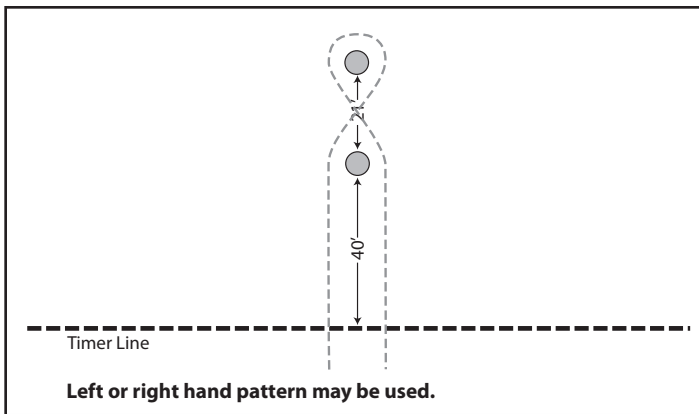

## PHOENIX LIGHTS RACE

### Equipment:

- 1 large barrel
- 6 poles

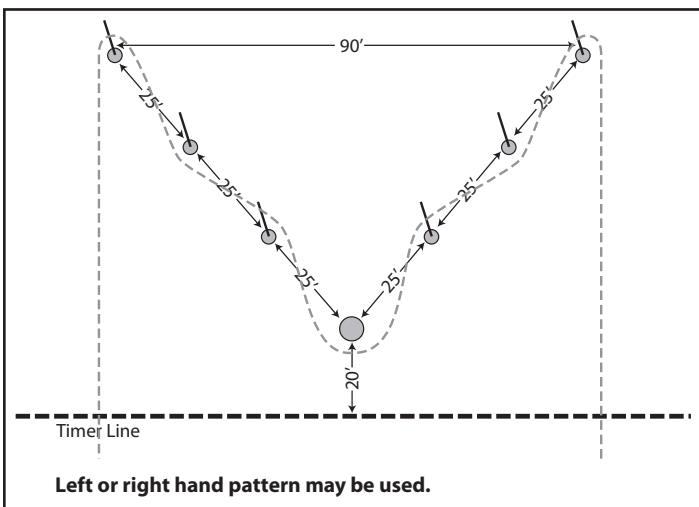

**Pattern:** Rider will cross timer line, go to far pole, turn around it, weave poles, turn around barrel, weave opposite side pole, turn end pole and run back across timer line.

Rider may run either right or left hand pattern.

**Penalties:** Five (5) second penalty added for each barrel or pole knocked over.

**Elimination:** Failure to complete pattern, breaking the pattern, crossing back over the starting line before completing the pattern, dismounting, fall of mount or rider.

## POLE BENDING

### Equipment:

- 6 poles

**Pattern:** Rider will cross timer line, starts either right or left, runs to the sixth (6) pole, pivots around pole, starts weaving in and out to the number one (1) pole, pivots around pole, weaving in and out to number six (6) pole, and run back across timer line. Rider may run either right or left hand pattern.

**Penalties:** Five (5) second penalty added for each pole knocked over.

**Elimination:** Failure to complete pattern. Breaking the pattern. Crossing back over the starting line before completing the pattern, dismounting, fall of mount or rider.

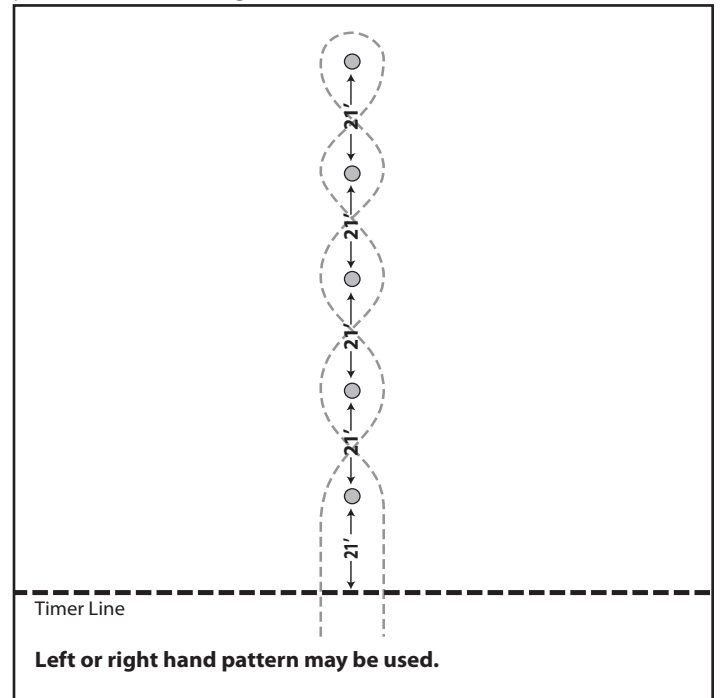

## POTATO RACE

### Equipment:

- 2 large barrels (1 with open end)
- small or medium potatoes

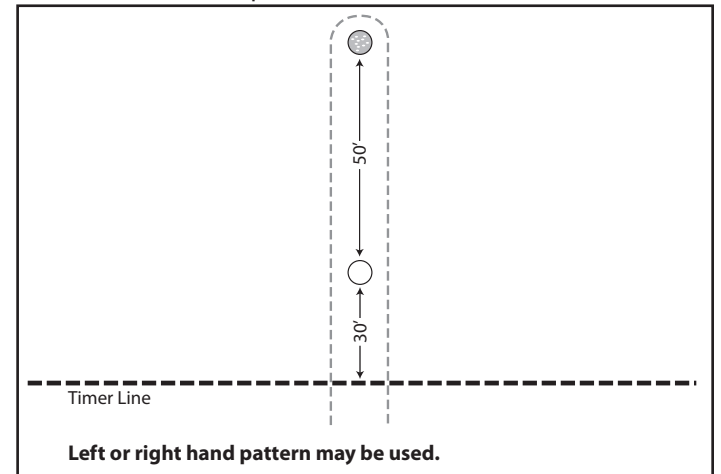

**Pattern:** Rider will cross timer line, make a 180 degree turn around the far barrel and pick up 1 potato off barrel, place potato into open end barrel and run back across timer line. Rider may run either right or left hand pattern.

**Penalties:** none

**Elimination:** Failure to complete pattern. Breaking the pattern. Knocking over barrel, dropping any potato on the end barrel, failure to place entire potato in goal barrel, crossing back over the starting line before completing the pattern, dismounting, fall of mount or rider.

# SECTION III: Competition

## PYRAMID RACE (AKA SPUR RACE)

### Equipment:

3 large barrels

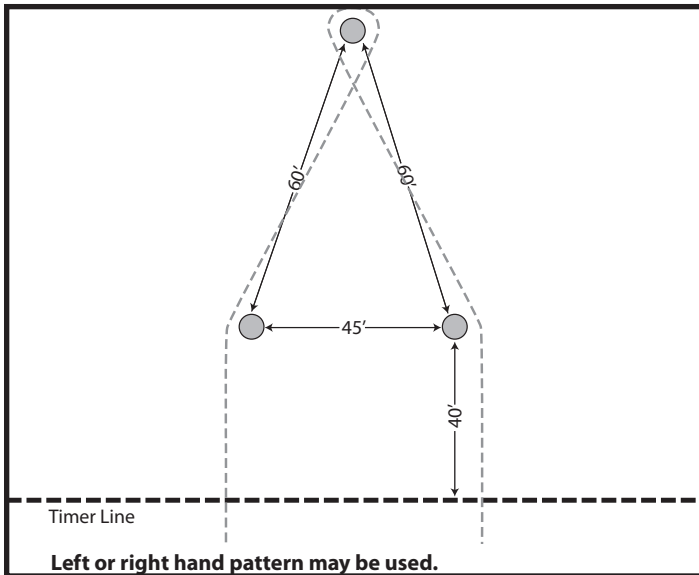

**Pattern:** Rider will cross timer line, passes on outside of first barrel, make 270 degree turn around the second barrel, pass on outside of the third barrel, and run back across timer line. Rider may run either right or left hand pattern.

**Penalties:** Five (5) second penalty added for each barrel knocked over.

**Elimination:** Failure to complete pattern, breaking the pattern, crossing back over the starting line before completing the pattern, dismounting, fall of mount or rider.

## QUADRANGLE RACE

### Equipment:

4 large barrels  
2 poles or pylons

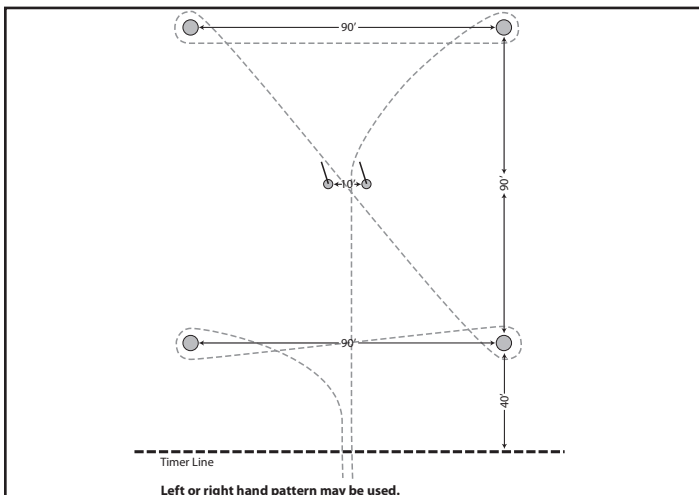

**Pattern:** Rider will cross timer line, make 270 degree turn around the first barrel, make 270 degree turn around the second barrel, pass between poles/pylons, I make a 270 degree turn around the third barrel, make a 270 degree turn around the fourth barrel, pass between poles/pylons and run back across timer line. Bowtie top set of barrels and figure 8 bottom set of barrels. Rider may run either right or left hand pattern.

**Penalties:** Five (5) second penalty added for each barrel or pole/ pylon knocked over.

**Elimination:** Failure to complete pattern, breaking the pattern, crossing back over the starting line before completing the pattern, dismounting, fall of mount or rider.

## REVERSE KEYHOLE RACE

### Equipment:

5 poles

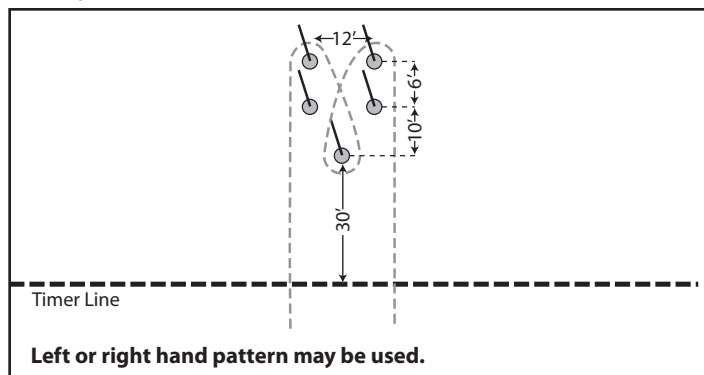

**Pattern:** Rider will cross timer line, go to far end pole and turn around it, go to center pole and make a 270 degree turn, go to pole opposite end far pole, turn around it and run back across timer line. Rider may run either right or left hand pattern.

**Penalties:** Five (5) second penalty added for each pole knocked over.

**Elimination:** Failure to complete pattern. Breaking the pattern. Crossing back over the starting line before completing the pattern, dismounting, fall of mount or rider.

## SCRAMBLE RACE

### Equipment:

1 large barrel  
3 poles  
1 jump

**Pattern:** Rider will cross timer line, weave poles, go over jump, 180 degree turn around barrel, back over jump, weave poles, and run back across timer line.

Rider may run either right or left hand pattern.

**Penalties:** Five (5) second penalty added for each barrel, pole or jump knocked over.

**Elimination:** Failure to complete pattern. Breaking the pattern. Failure to have all four feet of the mount go over each jump. Crossing back over the starting line before completing the pattern, dismounting, fall of mount or rider.



# SECTION III: Competition

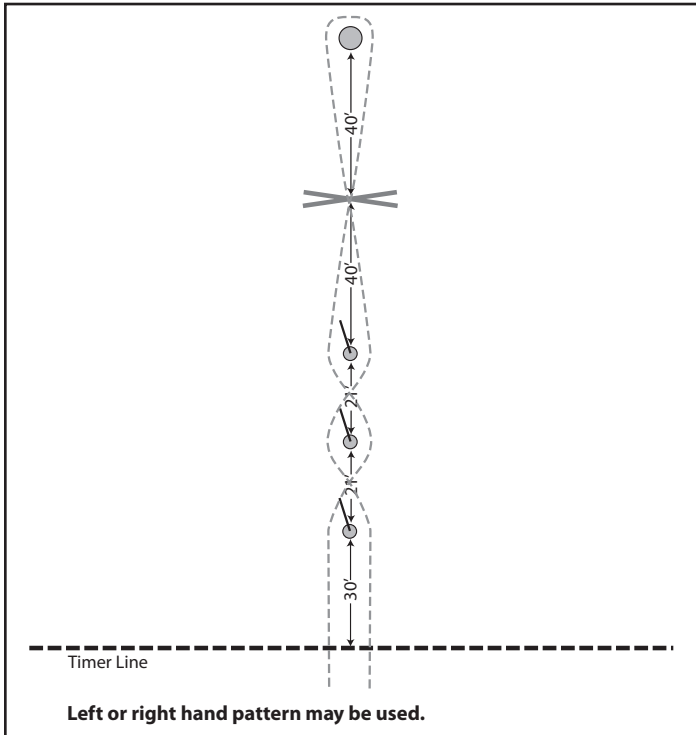

## SINGLE STAKE RACE OR SINGLE BARREL RACE (AKA SPEED RACE)

### Equipment:

1 large barrel or 1 pole

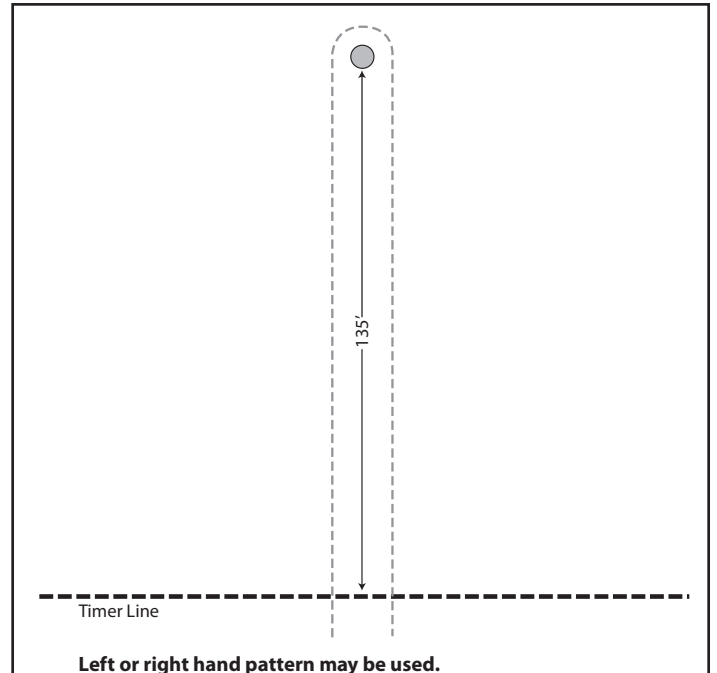

## SIDEWINDER RACE

### Equipment:

3 large barrels

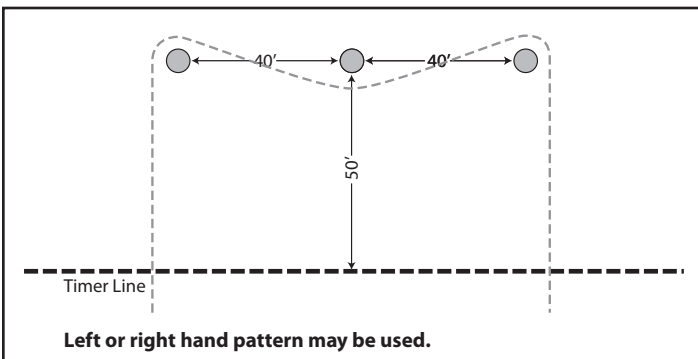

**Pattern:** Rider will cross timer line, turn around the first barrel, go on opposite side of second barrel, the opposite side of third barrel, and run back across timer line. Rider may run either right or left hand pattern.

**Penalties:** Five (5) second penalty added for each barrel knocked over.

**Elimination:** Failure to complete pattern, breaking the pattern, crossing back over the starting line before completing the pattern, dismounting, fall of mount or rider.

**Pattern:** Go through timing line to pole/barrel, turn pole/barrel (in either direction), and return across timing line. Rider may run either right or left hand pattern.

**Penalties:** Five (5) second penalty added for each barrel/pole knocked over.

**Elimination:** Failure to complete pattern, breaking the pattern, crossing back over the starting line before completing the pattern, dismounting, fall of mount or rider.

## SLANT RACE

### Equipment:

3 poles

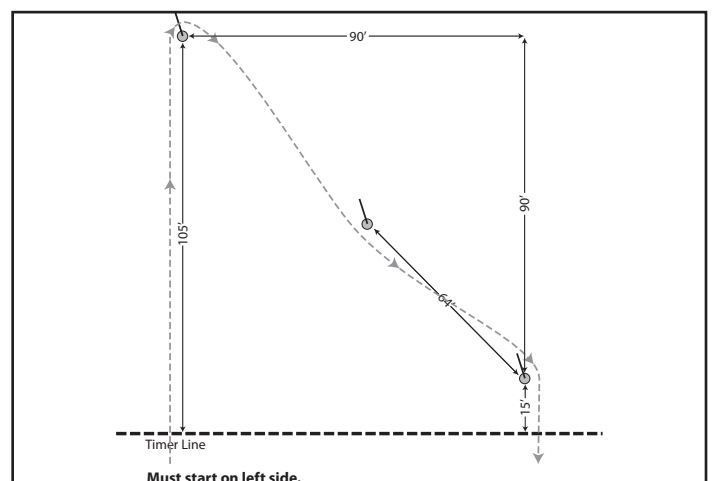

## SECTION III: Competition

**Pattern:** Rider will cross timer line, go to end pole and turn right around it, turn left around second pole, go right around third pole, and run back across timer line. Must start on left hand side.

**Penalties:** Five (5) second penalty added for each pole knocked over.

**Elimination:** Failure to complete pattern, breaking the pattern, crossing back over the starting line before completing the pattern, dismounting, fall of mount or rider.

### SPEED BALL RACE

**Equipment:**

- 1 large barrel
- golf ball or tennis ball
- cone

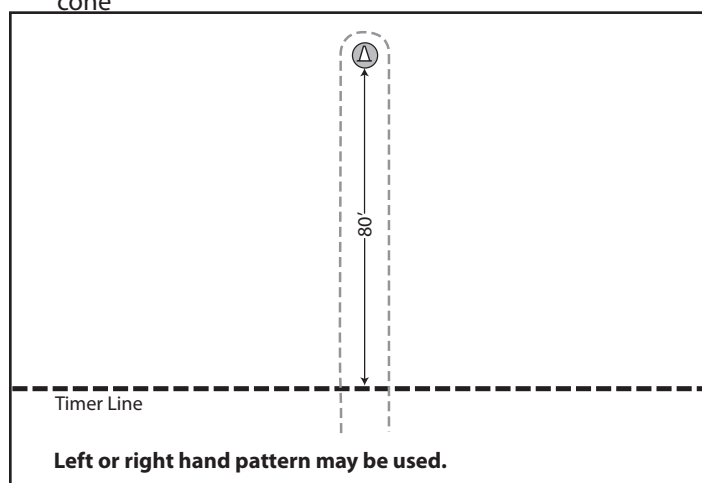

**Pattern:** Have ball in hand before start, ride down to barrel with ball and place ball into the cone on the barrel.

For advanced riders the barrel may be omitted and the cone placed directly on the ground. Rider may run either right or left hand pattern.

**Penalties:** None

**Elimination:** Failure to complete pattern, breaking the pattern, knocking over cone or barrel at any time while on course, failure to place ball into cone, crossing back over the starting line before completing the pattern, dismounting, fall of mount or rider.

### STAKE RACE

**Equipment:**

- 2 poles

**Pattern:** Rider will cross timer line, go down to the far pole and make a 270 degree turn, come back to the near pole and make a 270 degree turn the opposite direction, go back to the far pole and make a 270 degree turn the same direction as the first time, and run back across timer line. Rider may run either right or left hand pattern.

**Penalties:** None

**Elimination:** Failure to complete pattern, breaking the pattern, knocking over a pole, crossing back over the starting line before completing the pattern, dismounting, fall of mount or rider. If the mount and rider correct the mistake before the mount's shoulder goes past the pole by backing up to do so and then continuing with the pattern, they will NOT be eliminated. Once the mount's shoulder passes the pole, the pattern is broken resulting in eliminated.

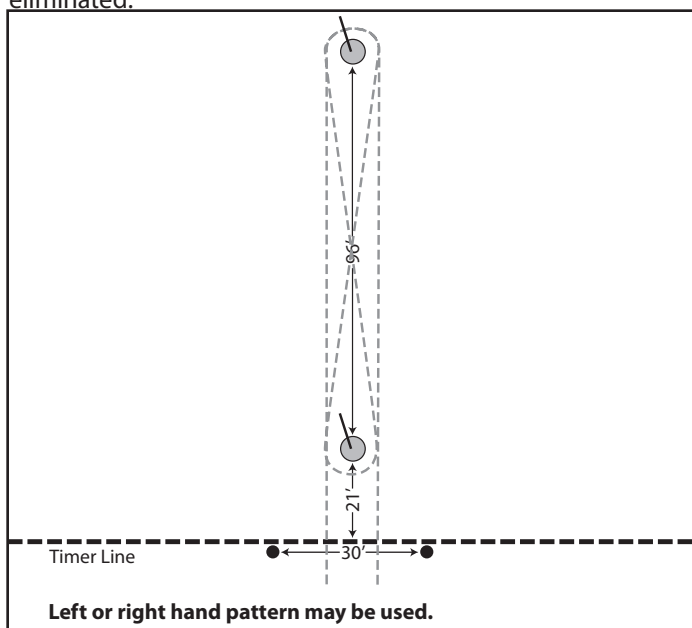

### STRAIGHT AWAY BARRELS RACE (AKA TEXAS BARREL RACE OR SPEED BARREL RACE)

**Equipment:**

- 3 large barrels

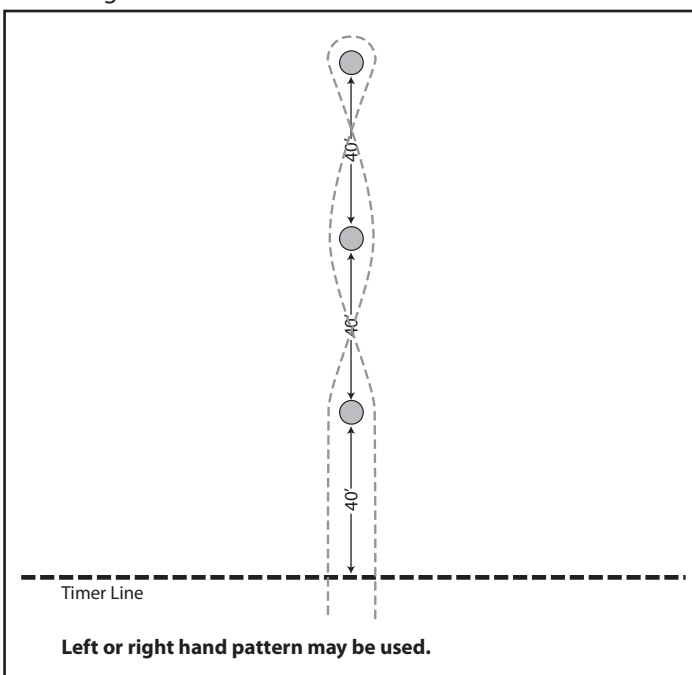

# SECTION III: Competition

**Pattern:** Rider crosses timer line weaving right or left of the barrel, continuing weaving in and out to third barrel, and weave back through to timer line. Rider may run either right or left hand pattern.

**Penalties:** Five (5) second penalty added for each barrel knocked over.

**Elimination:** Failure to complete pattern, breaking the pattern, crossing back over the starting line before completing the pattern, dismounting, fall of mount or rider.

## STREAKING POLES RACE

**Equipment:**

6 poles

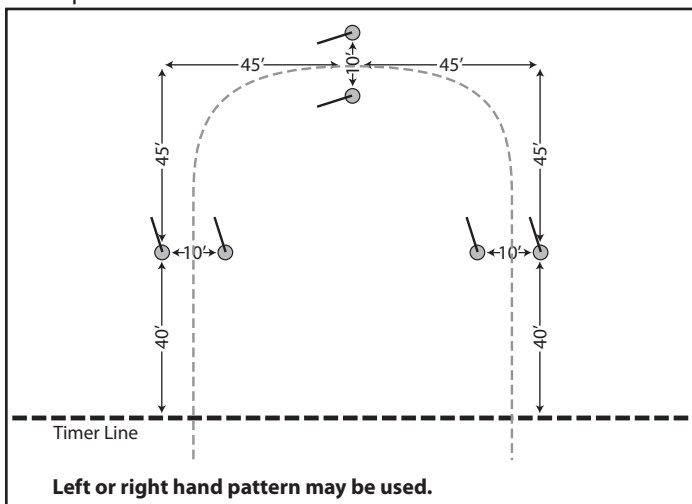

**Pattern:** Rider will cross timer line, pass through first set of poles, go through second set of poles, go through third set of poles, and run back across timer line. Rider may run either right or left hand pattern.

**Penalties:** Five (5) second penalty added for each pole knocked over.

**Elimination:** Failure to complete pattern, breaking the pattern, failure to pass between each set of poles, crossing back over the starting line before completing the pattern, dismounting, fall of mount or rider.

## TAIL SPIN RACE

**Equipment:**

5 poles

**Pattern:** Rider will cross timer line, turn left after the first pole and weave the remaining poles. Once they reach the final pole, they will turn left and run straight back across the timer line. Must start on right hand side.

**Penalties:** Five (5) second penalty added for each pole knocked over.

**Elimination:** Failure to complete pattern, breaking the pattern, crossing back over the starting line before completing the pattern, dismounting, fall of mount or rider.

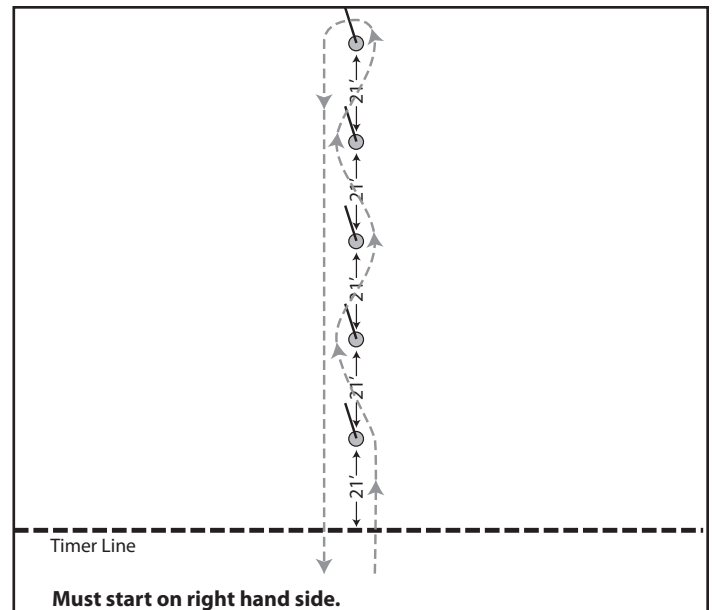

## THREAD THE NEEDLE RACE

**Equipment:**

12 poles

or 12 pylons

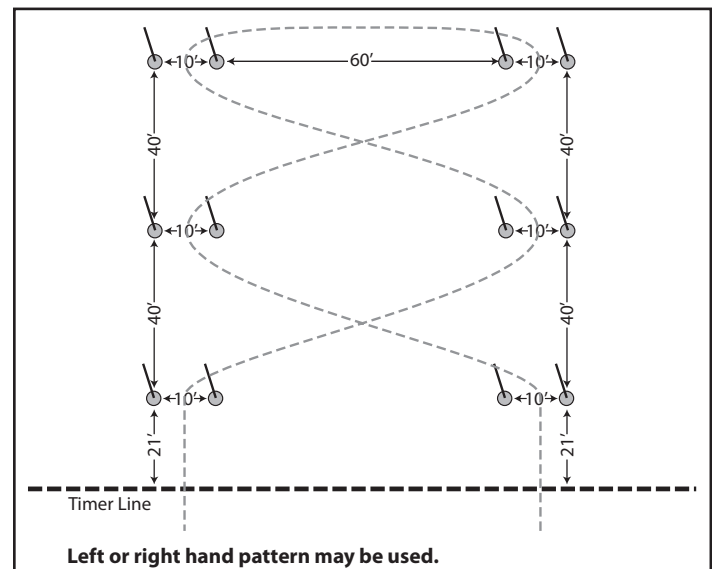

**Pattern:** Rider will cross timer line, go between first set of poles/pylons, go across arena and turn through second set of poles/pylons, go across arena and turn through third set of poles/pylons, go straight across arena and turn through fourth set of poles/pylons, go across arena and turn through fifth set of poles/pylons, go across arena and pass through sixth set of poles/pylons and run back across timer line. Rider may run either right or left hand pattern.

**Penalties:** Five (5) second penalty added for each pole/pylon knocked over.

**Elimination:** Failure to complete pattern, breaking the pattern, failure to go between each set of poles/pylons, crossing back over

# SECTION III: Competition

the starting line before completing the pattern, dismounting, fall of mount or rider.

## TUNNEL VISION RACE

### Equipment:

- 4 large barrels
- 4 poles

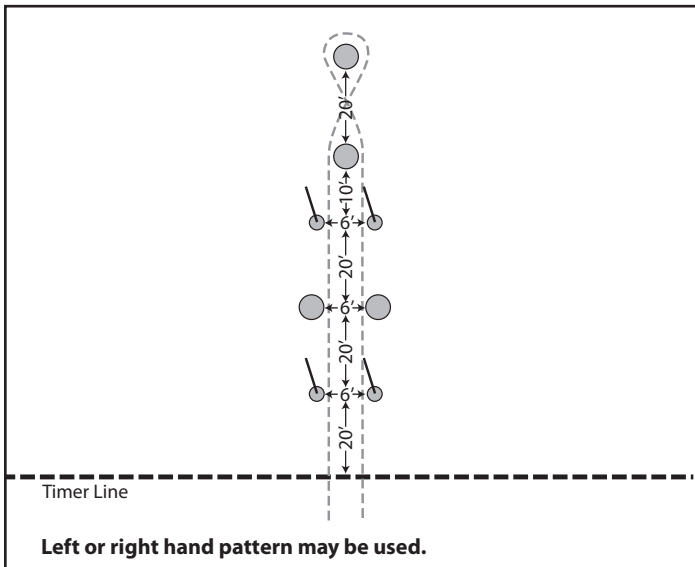

**Pattern:** Rider will cross timer line, go between the first set of poles, second set of barrels, set of poles and then figure 8 between last 2 barrels, go back between the second set of poles, set of barrels, first set of poles, and run back across timer line. Rider may run either right or left hand pattern.

**Penalties:** Five (5) second penalty added for each barrel or pole knocked over.

**Elimination:** Failure to complete pattern. Breaking the pattern. Crossing back over the starting line before completing the pattern, dismounting, fall of mount or rider.

## TURN N BURN RACE

### Equipment:

- 1 large barrel

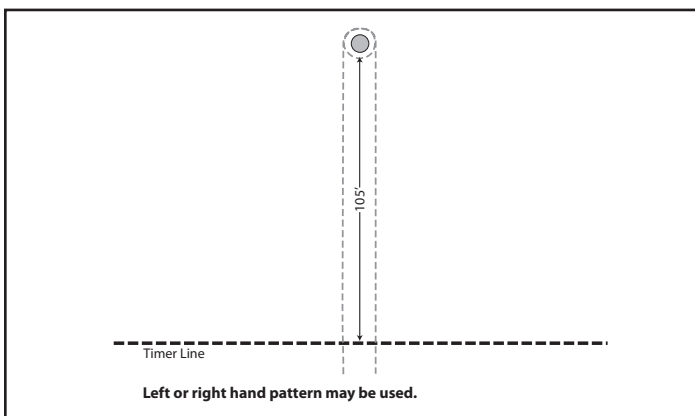

**Pattern:** Rider will cross timer line, make 540 degree turn around the barrel, and run back across timer line. Rider may run either right or left hand pattern.

**Penalties:** Five (5) second penalty added for each barrel knocked over.

**Elimination:** Failure to complete pattern. Breaking the pattern. Crossing back over the starting line before completing the pattern, dismounting, fall of mount or rider.

## TWO BARREL FLAG RACE

### Equipment:

- 2 small barrels with 8-10 inches of sand
- or 2 large barrels with sand buckets

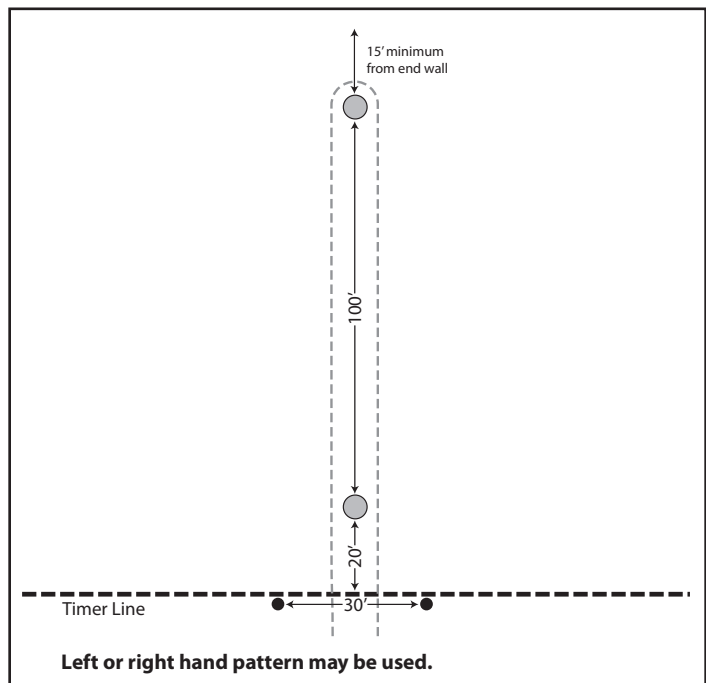

**Pattern:** Rider will cross timer line, rides to barrel A (side optional), and takes the flag; then, while riding around barrel B, the rider places the barrel A flag into barrel B and picks up the barrel B flag; the rider then puts the barrel B flag into barrel A as they pass, and run back across timer line. Riders must designate the flag positions before starting the course.

Rider may run either right or left hand pattern.

**Penalties:** None

**Elimination:** Failure to complete pattern, breaking the pattern, knocking over barrel/bucket or dropping flag, failure to pick up a flag from the barrel/bucket, crossing back over the starting line before completing the pattern, dismounting, fall of mount or rider.

# SECTION III: Competition

## TWO BARREL COWHORSE RACE

### Equipment:

2 large barrels

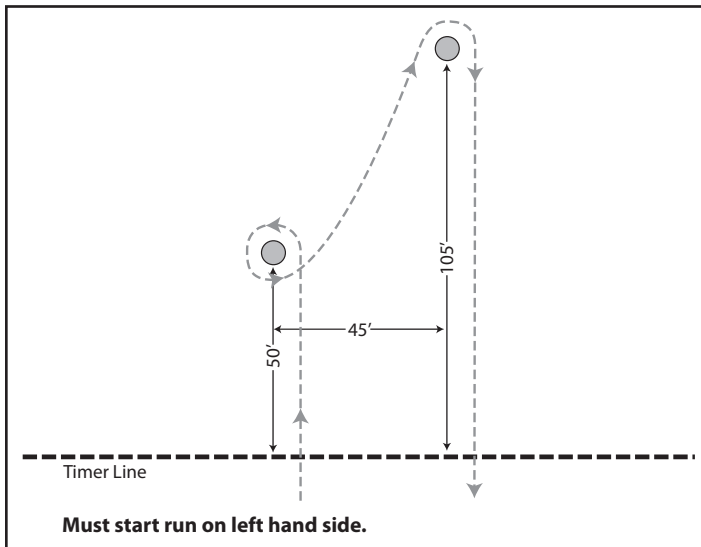

**Pattern:** Rider will cross timer line, go to the left barrel making left turn. Continue to next barrel making right turn, and run back across timer line. Must start on left hand side.

**Penalties:** Five (5) second penalty added for each barrel knocked over.

**Elimination:** Failure to complete pattern, breaking the pattern, crossing back over the starting line before completing the pattern, dismounting, fall of mount or rider.

## TWO JUMP COWHORSE RACE

### Equipment:

1 large barrel  
2 jumps

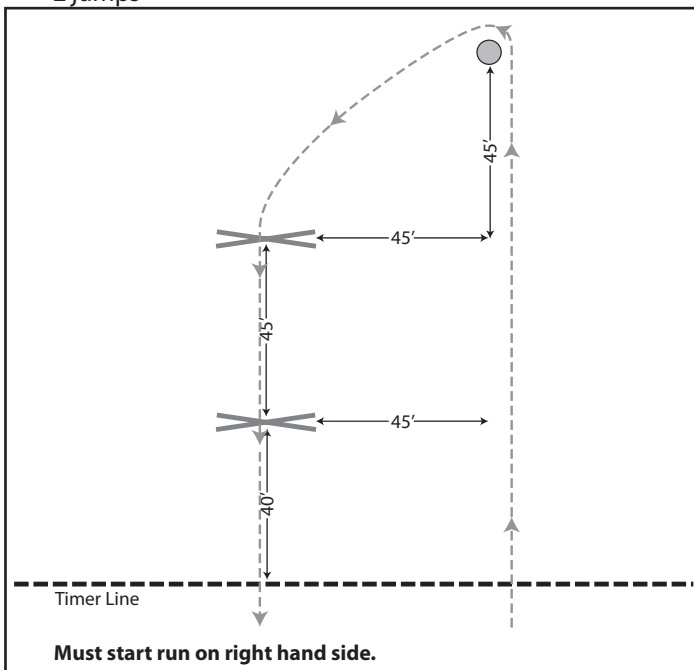

**Pattern:** Rider will cross timer line, turn left around barrel, go over both jumps and run back across timer line. Must start on right hand side

**Penalties:** Five (5) second penalty added for each barrel or jump knocked over.

**Elimination:** Failure to complete pattern, breaking the pattern, failure to have all four feet of the mount go over each jump, crossing back over the starting line before completing the pattern, dismounting, fall of mount or rider.

## WHY RACE

### Equipment:

2 large barrels  
3 poles

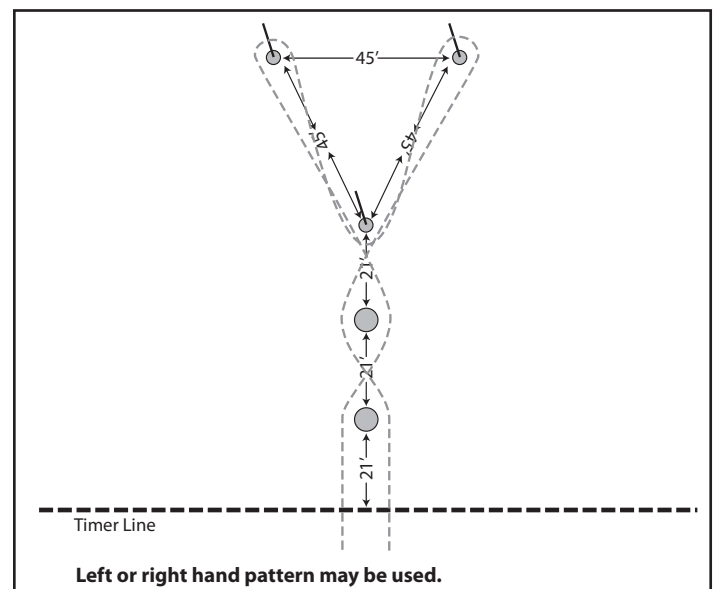

**Pattern:** Rider will cross timer line, on either side of the left or right side of the first barrel weaving between barrel one, two, and pole one. Continue from between barrel two and pole one to pole two. Turn around pole two and pass between pole 1 and barrel two to pole three. Turn around pole three, weaving through pole one and barrels one and two. The rider should complete the pattern on the opposite side of their entry.

Rider may run either right or left hand pattern.

**Penalties:** Five (5) second penalty added for each barrel or pole knocked over.

**Elimination:** Failure to complete pattern. Breaking the pattern. Crossing back over the starting line before completing the pattern, dismounting, fall of mount or rider.

# SECTION III: Competition

## WILD LARK RACE

### Equipment:

- 3 large barrels
- 4 poles

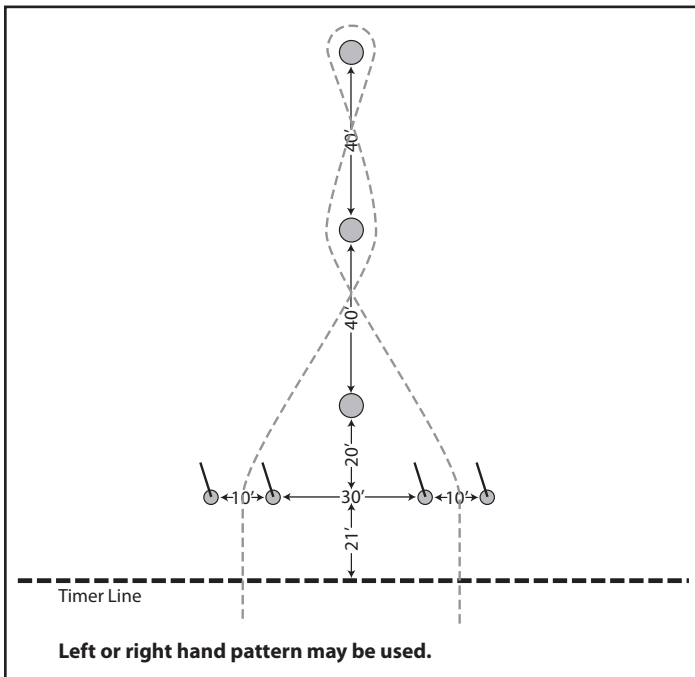

**Pattern:** Rider will cross timer line, go between first set of poles, weave up and back between the barrels, and pass through the other set of poles, and run back across timer line. Rider may run either right or left hand pattern.

**Penalties:** Five (5) second penalty added for each barrel or pole knocked over.

**Elimination:** Failure to complete pattern, breaking the pattern, crossing back over the starting line before completing the pattern, dismounting, fall of mount or rider.

## Chapter 4—Time

### Article 47—Timing

Time is counted from the instant the rider crosses the start line until the instant when the mount reaches the finishing line.

An electronic timer and reader board are recommended. If an electronic timer is not available, a hand-held stopwatch that measures times to the nearest hundredth may be used.

The start finish timed line must be marked with chalk, lime or paint if timing with a stop watch. When using electronic timing equipment marking the start finish line is optional.

### Article 48—Recording Time

Time is counted in hundredths of seconds (e.g., 16.23, 16.26 seconds). When an electronic timer is used for the start, the mount will break the beam.

# SECTION IV: Scoring

---

## Article 49—Points and Penalties

Scoring for the Gymkhana races will be on a positive point basis. The first place rider in each race is awarded 2 points more than the number of competitors competing in that race. The second place individual is awarded one point less than the number of competitors competing in that race, etc. (e.g., if 6 individuals competed in the race, the 1st place individual receives 8 points, 2nd place receives 5 points, 3rd place receives 4 points, 4th place receives 3 points, 5th place receives 2 points, 6th place receives 1 point.) An eliminated individual receives one point.

When scoring teams that include riders from different competition levels, the largest level will determine the points awarded. E.g., if there are 6 riders in one level and 4 riders in another level, the first placed riders in BOTH divisions receive 8 points, the second placed riders receive 5 points, the third placed riders receive 4 points, the fourth place riders receive 3 points. There are no fifth or sixth place riders for the smaller division; in the larger division the fifth place rider receives 2 points and the sixth place rider receives 1 point.

When scoring individual races, in the instance of a tie, both competitors will receive the points for that placing and the next highest placing will be skipped. E.g., if second place is tied, give each competitor 5 points, then skip third place. The next competitor would be further place and receive 3 points for the race.

## Article 50—Inquiries, Protests and Appeals

- Only competitors have the right to dispute scores and only competitors can participate in the process. Any non-competitor involvement in the process is considered unauthorized assistance.
- Competitors may only inquire about their team/individual scores.
- Inquiries are encouraged if there are any scores with which the team does not agree or understand, or if they feel a mistake has occurred. Any disputes regarding scores are to be made following the procedures as stated in the governing documents.
- All inquiries, protests and appeals must be made in a polite and courteous manner. Abuse of these procedures or rude behavior may be penalized up to and including elimination and/or disqualification.
- The process will include verbal inquiry, written inquiry, written protest and written appeal, and use Appendix I.

## Horse Management

### Horse Management Verbal Inquiry

Verbal inquiries may be initiated if the team captain/individual competitor does not agree or understand or if they feel a mistake has been made. Horse management verbal inquiries are made to the CHMJ following the posting of scores.

### *Inquiries must be:*

Initiated within 30 minutes from the time the score sheet(s) are posted by the CHMJ, and made in person by:

- The team captain, if competitor is on a team. The competitor involved may go with the team captain.
- The competitor involved (if competing as an individual). If the team captain is riding when scores are posted and will not be available within the allowed thirty-minute period, another team member may notify the CHMJ that an inquiry is likely.

At the end of the required 30 minute inquiry period, the CHMJ must:

- Make any necessary adjustments/changes to scores based on the outcome of any inquiries that may have been made and are settled. (Only the CHMJ may adjust points as a result of inquiries.)
- Transcribe any changes in scores to the HM master score sheet and turn in master score sheet to the rally scorer.
- No further inquiries will be permitted, except for transcription errors. Transcription errors are a discrepancy between actual scores shown on horse management sheets and scores posted by the scorer.

### Horse Management Written Inquiry

Written inquiries may be initiated if the team captain/individual competitor disagrees with the CHMJ's decision on a verbal inquiry. Written inquiries are made to the TD/steward via the rally office.

### *Written Inquiries must be:*

Made in writing, using the official horse management written inquiry form (signed by the team captain/individual competitor), containing the references to the rules covering the reason for the inquiry Section VI, Chapter 24, delivered within 30 minutes of the CHMJ decision on the verbal inquiry to the rally office.

## Mounted Competition

### Mounted Competition Scoring Written Inquiry

Written inquiries may be initiated if the team captain/ individual competitor does not agree or understand or if they feel a mistake has been made. Mounted competition written inquiries are made to the TD/steward following the posting of scores.

### *Inquiries must be:*

Initiated within 30 minutes from the time the score sheet(s) are posted and made in person by:

- The team captain, if competitor is on a team. The competitor involved may go with the team captain.

## SECTION IV: Scoring

---

- The competitor involved (if competing as an individual). If the team captain is riding when scores are posted and will not be available within the allowed thirty-minute period, another team member may notify the rally office that an inquiry is likely.

### Written Protest to the Discipline Ground Jury

If a team does not agree with the TD/steward's decision on a written inquiry, they may advance a written protest (utilizing the existing written inquiry form) to the discipline ground jury.

The decision must be made while the team is sequestered and within 10 minutes after the TD/steward's announcement of the decision to the team.

*Written Protests must be:*

Initiated by:

- The team captain, if competitor is on a team. The competitor involved may go with the team captain.
- The competitor involved (if competing as an individual).
- Made within 10 minutes of the TD/steward's announcement of the decision to the team.

### Frivolous Protest

- During a rally, each team is allowed one "free" protest to the TD. After the first, the TD may present to the ground jury any protest presented in which the decision of the judge was upheld and which the TD deems frivolous and not in the spirit of good sportsmanship. Any protest deemed frivolous, may be assessed 5 points by the ground jury.
- If any score change results, the chief scorekeeper must be notified by the official making the decision and changes recorded scores.

The ground jury will meet, review the written inquiry/protest form, make a decision, document the decision on the original written inquiry/protest form, and report its decision.

THE DECISION OF THE DISCIPLINE GROUND JURY IS FINAL AT REGIONAL RALLIES.

### Written Appeal to the Championships Overall Ground Jury

If a team does not agree with the discipline ground jury's decision on a written protest, they may advance an appeal (utilizing the existing written inquiry form) to the championships overall ground jury.

The team's decision to appeal must be made while the team is sequestered and within 10 minutes after the announcement of the discipline ground jury's decision to the team.

*Appeals must be initiated by:*

- The team captain, if competitor is on a team. The competitor involved may go with the team captain.
- The competitor involved (if competing as an individual).

THE DECISION OF THE CHAMPIONSHIPS OVERALL GROUND JURY IS FINAL.

### Article 51—Scoring of Excused

Mounts excused after the beginning of competition will receive elimination scores for all of the following races, unless they are later judged to be sound and allowed to compete again.

### Article 52—Scoring of Elimination

A score of 1 will be given on each race where the competitor has been eliminated.

### Article 53—Scoring of Disqualification

The discipline ground jury may disqualify a competitor and/ or a team from competition, for the reasons stated in Article 21. Or the discipline ground jury may decide to issue a Yellow (Warning) Card in lieu of disqualifying a competitor. Decisions of the discipline ground jury are not appealable except at Championships.

1. If a Yellow Card is assessed to a competitor, it may or may not include penalty points. The discipline ground jury can assess penalties ranging from 0 up to the maximum penalties as defined below. Any assessed penalties should be included in the "Other" column on the scoresheet and are deducted from the positive point score prior to combining them with the horse management Score.
  - A. Single Race—The maximum number of penalties accessible for infractions related to a single race is calculated by taking the number of teams in the division and adding 2, then dividing the total by 2.
  - B. Entire Competition Infraction—The maximum number of penalties accessible for infractions related to a single race is calculated by taking the number of teams in the division and adding 2, then dividing the total by 2. Next, multiply the number just calculated by the number of races included in the competition.
3. Competitors (or teams) who are disqualified from competition shall have all their scores from the competition stricken. If the disqualification of a competitor causes an already short team, to become a shortened team, then shortened team ghost scoring will apply. If a stable manager is disqualified, all the team's accumulated horse management points will be split evenly among the remaining team members.

Disqualified competitors and their mounts may not take further part in the rally and may be asked to leave the grounds. A disqualified competitor/team may not receive an award.



# SECTION IV: Scoring

---

## Article 54—Team Scoring

1. Based on the number of mounted competitors, teams may or may not have a drop score. Four rider teams will drop the worst (lowest) score for each round of races. Three rider teams will keep all three scores from each race. If horse management ghost scores are needed, those will be calculated per the current Horse Management Handbook.

Team totals will be calculated by totaling final riding scores with the horse management bonus score for the team totals. The final score is calculated using the below formula.

Overall Score = Riding Score + HM bonus score

HM Bonus Score = (number of races run x 3)—(number of HM penalties)

\* Note the HM bonus score could possibly be a negative number that reduces rather than increases the total score.

2. In extraordinary circumstances when a short team (three rider team) becomes a shortened team (two rider and one stable manager), prior to the start of competition, the following team scoring will take effect.
  - A. In the event of the competitor being removed completely from the team, ghost horse management scores will be determined per the Horse Management Handbook. Ghost riding scores will be determined by averaging the riding scores of the two remaining competitors.
  - B. In the event of the competitor no longer being able to participate in the riding portion of the competition, they shall continue to earn horse management scores, and ghost riding scores will be determined by averaging the riding scores of the two remaining competitors.

Please note: The above scoring is not to be used in a 4 man team's loss of a rider or mount. Only to be used with a 3 man team rather than losing a team completely from the rally.

## Article 55—Individual Scoring

While rallies are normally scored only as teams. There are some instances when the tabulation of individual scores is necessary. To determine an individual's score:

1. The points accumulated in each race of the competition will be added together.
2. The total score, plus all horse management penalties (after factoring), will be added.
3. The winning individual is that individual who has the highest total score after all scores have been added.

## Article 56—Posting Scores

Depending on the length of the rally, scores may be posted multiple times during the rally or just once. Any time scores are posted there is a 30-minute inquiry period where competitors can inquiry regarding the scores (Article 50). After the final inquiry period, the only changes that can occur are if a transcription error has occurred. Following the final inquiry period, final scores for all competitors must be posted for review by competitors, parents, coaches, etc.

Anytime scores are posted during the competition, there will be an announcement of official score posting and time.

## Article 57—Placing of Teams

The winning team is that with the best (highest) final score after riding scores and the factored horse management penalties are added together.

Ties:

In a team competition, ties will be decided on the following conditions:

- A. Number of first place finishes
- B. Number of second place finishes
- C. Turnout Inspection scores (four) for each team.

Awards:

Overall team and horse management awards are usually presented at mounted rallies. Other awards may be also be given and all awards must be published in the prize list.

Please Note: A disqualified mount/rider combination may not be placed or receive an award.

# SECTION V: Officiation

---

## Overview

The use of appropriately licensed (US Equestrian, etc.) officials is always preferable. Regarding standard rallies, appropriately licensed officials may be required. However, realizing that not every area has Pony Club-oriented licensed officials easily available, rally organizers are asked to utilize suitably experienced personnel to fill official positions. Organizers needing help are encouraged to reach out to the Competitions Committee (refer to [www.ponyclub.org/About/Contact Us/ActivitiesCommittees](http://www.ponyclub.org/About/Contact%20Us/ActivitiesCommittees) to find contact information for the USPC committee members). These resource people, available by e-mail, or phone, can help with courses, officials, or other questions.

## Article 58—Rally Organizer

The rally organizer serves as the manager of the competition. They must be on the grounds during competition and available to rally officials in the event a problem arises concerning the facility or equipment. Rally organizers do not participate in the officiation, unless required due to extenuating circumstances. They must engage individuals necessary to fill all official capacities at the competition. Full details and job descriptions for rally organizers are available in the Rally Organizer's Guide.

## Article 59—Technical Delegate (TD)

The TD is the person to whom an inquiry is presented by the team captain in the event of a question regarding mathematical errors or scoring irregularities. If the initial inquiry to the TD fails to resolve the question at hand, the discipline ground jury then makes a final decision. The TD may not be a member of the discipline ground jury.

Per the appropriate discipline rulebook the organizer shall appoint a knowledgeable person to serve as TD. The TD shall act with complete impartiality and report to the organizer and appropriate discipline committee, protecting the interests of competitors, judges, officials and the competition organizers. The TD shall have no connection with the management or judging of a competition. No Pony Club rally competition shall be organized and held without the presence of a TD.

The TD is responsible for:

- A. Ensuring the competition is organized and managed in strict compliance with the appropriate discipline rules
- B. Inspecting competition facility prior to the competition with appropriate officials
- C. Supervising the horse inspection(s)
- D. Once the competition begins, the TD is responsible for accounting for the presence of all competitors and mounts on rally grounds. Any withdrawals of mounts or riders must be reported to the TD as soon as possible.
- E. Supervising the technical conduct of the competition.
- F. Reporting any infraction or violation of the competition rules and regulations to the organizer or appropriate

people, by any competitor, coach, manager, competition official, staff member or any other person present on the competition grounds, and seeing that immediate action is taken

- G. Protecting the interests of competitors, judges, officials and the competition organizers
- H. Furnishing USPC with a complete written report on the competition, including any infractions or violations of the rules, within three days following completion of the competition. (See Appendix IV).

The TD is authorized to insist on alterations to the facility and competition areas if, in their opinion, they do not comply with the established limits for the competition.

## Article 60—Discipline Ground Jury

The discipline ground jury is the group that adjudicates the rally. The discipline ground jury makes proper inquiries into both sides of cases in all protests concerning decisions made by the TD and other officials during a rally.

The discipline ground jury shall be composed of the chief judge, chief horse management judge (CHMJ), and one other Pony Club Gymkhana knowledgeable person as appointed by the rally organizer. The following persons are ineligible to serve on the discipline ground jury:

1. Any competitor, manager, chaperone, coach, or owner of a mount entered in the competition
2. Any close relative of a person named in item 1. above
3. Any instructor or trainer of any competitor or mount entered in the competition
4. The organizer or any member of the organizing committee
5. No other horse management judge from that competition
6. The TD

### Duties of the discipline ground jury:

- A. The discipline ground jury is ultimately responsible for the judging of the rally and for settling all problems that may arise during its jurisdiction. Together with the TD and organizing committee shall ensure that all arrangements for the rally, including that all competition areas are appropriate. If, after consultation with the TD, the discipline ground jury is not satisfied with the arrangements or areas, it has the authority to modify them.
- B. The discipline ground jury will be responsible for determining objections against decisions by technical personnel, including judges and time-keepers, and may substitute their judgement for that of any judge or official, whether or not in favor of the competitor.
- C. The members of the discipline ground jury are obliged to be on the grounds from the official rally opening until awards have been made.

# SECTION V: Officiation

---

- D. Any member of the discipline ground jury has the duty and authority at any time during the rally to disqualify any competitor who is unfit to continue because of physical exhaustion or impairment, abusive or dangerous behavior. There is no appeal against such a decision.

## Article 61—President of the Discipline Ground Jury

The president of the ground jury will be the chief judge of the competition.

## Article 62—Championships Overall Ground Jury

At championships (when multiple disciplines are competing at the same time and on the same facility), there will be a championships overall ground jury composed of three to five persons to include: the VPA (if not the organizer), the championships horse management organizer, and one or more knowledgeable mount persons designated by the organizer, one of whom will be designated president.

The purpose and duties of the championships overall ground jury include:

- Determine dress requirements for turnout inspections and competition; and responsibility for waiving of dress requirements when the heat/humidity index so indicates
- Decide issues that affect all disciplines at championships, so as to promote uniformity among the competitions
- Handle instances regarding the uniform application of disciplinary action for poor sportsmanship, cruelty or misbehavior by a competitor
- Make a proper inquiry into both sides of the cases in all appeals concerning decisions made by the discipline ground jury, or referred to the championships overall ground jury by the discipline ground jury

The decision of the championships overall ground jury is final.

The following may not serve on the championships overall ground jury:

- Anyone serving as a TD
- Anyone serving on a discipline ground jury
- Anyone serving as a CHMJ for the competition
- Anyone serving as a judge for the competition

## Article 63—Horse Management Judges

1. All rallies shall include judging of Horse Management. Horse Management shall be judged in accordance with current USPC Horse Management Handbook. At all events, horse management judges will judge safety standards throughout the day.
2. The horse management judges shall be responsible for conducting stable, turnout and turnback inspections.

3. Horse management judges shall be responsible for safety checks. The safety checks will be performed in assigned areas, as close to warm up and jumping areas as feasible.

## Article 64—Chief Horse Management Judge (CHMJ)

One member of the rally horse management staff will be designated as the CHMJ. If the rally is a standard rally for Championships, the CHMJ must be selected from the CHMJ list on the USPC website.

## Article 65—Spotters

The need for spotters during Gymkhana races depends on the rallies' race list for the day. The chief judge will make the determination if spotters are necessary. The number spotters will vary between 0-4 depending on the race and the size of the arena. They will be placed around ring at certain vantage points. After each competitor completes a race, they will hold up a paddle. A white paddle side indicates no elimination was identified, a red paddle side indicates an elimination was identified. Other forms of identification are also acceptable (i.e. hand signals or radios).

## Article 66—Chief Judge

The rally organizer shall appoint a chief judge for the competition. The chief judge oversees and approves the placement and set up of each race. The chief judge also serves as the starter of each race, signaling competitors at the start and finish of each race. The decision of the chief judge is final relating to all events taking place in the competition arena and the entering and exiting of the arena. The chief judge will use a white flag to signal competitors at the start and finish of each race. It is acceptable to use a loud verbal signal instead of a flag at regional rallies.

## Article 67—Inspection Panel

An inspection panel made up of the president of the discipline ground jury, the CHMJ, and a veterinarian or other qualified mount person, will officiate over the mount inspections (jogging). The veterinarian's decision shall be final when a judge or the steward requests an inspection or examination as to the serviceable soundness of a mount. In the absence of a veterinarian, the judges or the steward shall have the right to excuse a mount from further participation on the grounds of unsoundness.

## Article 68—Veterinarian

1. The veterinarian should be a part of the inspection panel for all mount inspections.
2. Regional competitions should have a qualified veterinarian present or on call for all phases of the competition.
3. The veterinarian shall assist the organizer in all matters pertaining to the health and welfare of the mounts at the competition.
4. The veterinarian, when required to be present at a competition, shall have the right to inspect and examine

# SECTION V: Officiation

---

any mount at the competition. The judges or the steward may request an inspection or an examination of any mount.

5. The veterinarian's decision shall be final when a judge or the steward request an inspection or examination as to the serviceable soundness of a mount. In the absence of a veterinarian, the judges or the steward shall have the right to excuse a mount from further participation on the grounds of unsoundness.
6. In any suspected case of use of drugs, the veterinarian shall be permitted to take blood, urine and/or saliva sample(s) to test for drug residues.

## Article 69—Chief Scorer

1. The chief scorekeeper is responsible for prompt and accurate scorekeeping. The judges and timekeepers provide factual data for the chief scorekeeper to use in the calculation of scores and place standings.
2. Accurate, up-to-the-minute scorekeeping is very important to keep the competitors, officials and spectators informed. Therefore, the judges and the chief scorekeeper shall work in close cooperation with the announcer.
3. The chief scorekeeper shall appoint such assistants as they may require for the work. All scoring shall be conducted with complete impartiality.

## Article 70—Required Medical Personnel

1. For mounted rallies—An EMT-Basic (paid or volunteer) is required onsite one hour prior to the first ride of the rally and stay until riding concludes for the day. The EMT or rally organizer must be aware of the closest ambulance and hospital locations.

2. The EMT must:

- Have CPR certification and license to perform basic assessment and non-invasive treatment.
- Not have any other duties at the mounted rally.
- Have a reliable means of communicating with the local EMS service and knowledge of the nearest hospital.
- Have direct communication with all riding areas, especially those out of view.
- Coordinate with the rally organizer on how to handle injured parties.

3. Additional Information:

- An EMT who is Intermediate or Paramedic level, both meets and exceeds the minimum requirement.
- Facility requirements may exceed the minimum USPC EMT requirement.
- Rallies run as recognized events may exceed the minimum USPC EMT requirement.
- An on-site ambulance is highly recommended, but not required.

# SECTION VI: Appendices

---

## Appendix I: Mounted Competition Scoring Inquiry/Protest/Appeal Form

*Remember*

- Only competitors have the right to dispute scores and can participate in the process
- Before this form can be used, a verbal inquiry must have been made to the CHMJ for Horse Management score questions
- After submission to the TD/steward, no additional information can be added by the team

Date: \_\_\_\_\_ Discipline: \_\_\_\_\_ Division: \_\_\_\_\_ Team #: \_\_\_\_\_

Team Captain Name and Phone Number: \_\_\_\_\_

Team Member # for Protest: \_\_\_\_\_ Team Member Certification: \_\_\_\_\_

State infraction and provide points assessed:

Statement of Protest:

References (Name reference and page number):

Signature of Team Captain/Competitor: \_\_\_\_\_

# SECTION VI: Appendices

## Appendix I: Mounted Competitions Inquiry/Protest/Appeal Form

### Written Inquiry/Protest/Appeal Review

#### For Official Use Only

---

Written Inquiry Disposition: Date/time: \_\_\_\_\_

Approved: \_\_\_\_\_ Denied: \_\_\_\_\_ Points awarded if any: \_\_\_\_\_

TD: \_\_\_\_\_

CHMJ (if HM related) \_\_\_\_\_

Team Captain: \_\_\_\_\_

Requesting Advance to Protest Yes: \_\_\_\_\_ No: \_\_\_\_\_

---

Protest Disposition: Date/time: \_\_\_\_\_

Approved: \_\_\_\_\_ Denied: \_\_\_\_\_ Points awarded if any: \_\_\_\_\_ Penalty, if any: \_\_\_\_\_

Discipline Ground Jury: \_\_\_\_\_

Team Captain: \_\_\_\_\_

Requesting Advance to Appeal (Championships ONLY) Yes: \_\_\_\_\_ No: \_\_\_\_\_

---

Appeal Disposition: Date/time: \_\_\_\_\_

Approved: \_\_\_\_\_ Denied: \_\_\_\_\_ Points awarded if any: \_\_\_\_\_ Penalty, if any: \_\_\_\_\_

Discipline Ground Jury/Appeal Committee (Championships ONLY): \_\_\_\_\_

Team Captain: \_\_\_\_\_

---

Received by Scorer: (to indicate receipt and adjustment of a change)

\_\_\_\_\_

# SECTION VI: Appendices

## Appendix II: Heat Illness and Heat Index Chart

HEAT ILLNESS	Symptoms	What to do
Heat Stroke	<ul style="list-style-type: none"> <li>• Confusion</li> <li>• Fainting</li> <li>• Seizures</li> <li>• Excessive sweating or red, hot, dry skin</li> <li>• Very high body temperature</li> </ul>	<ul style="list-style-type: none"> <li>• Contact Medical Personnel, EMT, or Call 911</li> </ul> <p><i>While waiting for help:</i></p> <ul style="list-style-type: none"> <li>• Place person in shady, cool area</li> <li>• Loosen clothing, or remove outer clothing</li> <li>• Fan air, place ice packs in armpits, apply cool compresses</li> <li>• Provide fluids (water)</li> </ul>
Heat Exhaustion	<ul style="list-style-type: none"> <li>• Cool, moist skin</li> <li>• Heavy sweating</li> <li>• Headache</li> <li>• Nausea or vomiting</li> <li>• Dizziness</li> <li>• Light Headaches</li> <li>• Weakness</li> <li>• Thirst</li> <li>• Irritability</li> <li>• Fast Heart Beat</li> </ul>	<ul style="list-style-type: none"> <li>• Place person in shady, cool area</li> <li>• Provide fluids (water)</li> <li>• Cool person with cold compresses, ice packs, fans</li> </ul>
Heat Cramps	<ul style="list-style-type: none"> <li>• Muscle Spasms</li> </ul>	<ul style="list-style-type: none"> <li>• Rest in cool, shaded area</li> <li>• Drink water</li> <li>• Wait a few hours before returning to play</li> </ul>

Temperature (°F)	Relative Humidity (%)																				
	5	10	15	20	25	30	35	40	45	50	55	60	65	70	75	80	85	90	95	100	
80	77	78	78	79	79	79	80	80	80	81	81	82	82	83	84	84	85	86	86	87	
81	78	79	79	79	79	80	80	81	81	82	82	83	84	84	85	86	86	87	88	90	91
82	79	79	80	80	80	80	81	81	82	83	84	84	85	86	88	89	90	91	93	95	95
83	79	80	80	81	81	81	82	82	83	84	85	86	87	88	90	91	93	95	97	99	99
84	80	81	81	81	82	82	83	83	84	85	86	88	89	90	92	94	96	98	100	103	103
85	81	81	82	82	82	83	84	84	85	86	88	89	91	93	95	97	99	102	104	107	107
86	81	82	83	83	83	84	85	85	87	88	89	91	93	95	97	100	102	105	108	112	112
87	82	83	83	84	84	85	86	87	88	89	91	93	95	98	100	103	106	109	113	116	116
88	83	84	84	85	85	86	87	88	89	91	93	95	98	100	103	106	110	113	117	121	121
89	84	84	85	85	86	87	88	89	91	93	95	97	100	103	106	110	113	117	122	126	126
90	84	85	86	86	87	88	89	91	92	95	97	100	103	106	109	113	117	122	127	132	132
91	85	86	87	87	88	89	90	92	94	97	99	102	105	109	113	117	122	126	132	137	137
92	86	87	88	88	89	90	92	94	96	99	101	105	108	112	116	121	126	131	136	141	141
93	87	88	89	89	90	92	93	95	98	101	104	107	111	116	120	125	130	136	141	146	146
94	87	89	90	90	91	93	95	97	100	103	106	110	114	119	124	129	135	141	146	151	151
95	88	89	91	91	93	94	96	99	102	105	109	113	118	123	128	134	140	146	151	156	156
96	89	90	92	93	94	96	98	101	104	108	112	116	121	126	132	138	145	151	156	161	161
97	90	91	93	94	95	97	100	103	106	110	114	119	125	130	136	143	150	156	161	166	166
98	91	92	94	95	97	99	102	105	109	113	117	123	128	134	141	148	155	161	166	171	171
99	92	93	95	96	98	101	104	107	111	115	120	126	132	138	145	153	160	166	171	176	176
100	93	94	96	97	100	102	106	109	114	118	124	129	136	143	150	158	165	171	176	181	181
101	93	95	97	99	101	104	108	112	116	121	127	133	140	147	155	162	170	176	181	186	186
102	94	96	98	100	103	106	110	114	119	124	130	137	144	152	160	167	175	181	186	191	191
103	95	97	99	101	104	108	112	116	122	127	134	141	148	157	165	172	180	186	191	196	196
104	96	98	100	103	106	110	114	119	124	131	137	145	153	161	168	176	182	188	193	198	198
105	97	99	102	104	108	112	116	121	127	134	141	149	157	166	173	181	187	192	197	202	202
106	98	100	103	106	109	114	119	124	130	137	145	153	162	172	179	186	192	197	202	207	207
107	99	101	104	107	111	116	121	127	134	141	149	157	167	176	183	190	196	201	206	211	211
108	100	102	105	109	113	118	123	130	137	144	153	162	172	180	187	193	198	203	208	213	213
109	100	103	107	110	115	120	126	133	140	148	157	167	177	185	192	197	202	207	212	217	217
110	101	104	108	112	117	122	129	136	143	152	161	171	180	187	193	198	203	208	213	218	218
111	102	106	109	114	119	125	131	139	147	156	166	176	185	192	197	202	207	212	217	222	222
112	104	107	111	115	121	127	134	142	150	160	170	181	190	197	202	207	212	217	222	227	227
113	104	108	112	117	123	129	137	145	154	164	175	184	191	197	202	207	212	217	222	227	227
114	105	109	113	119	125	132	140	148	158	168	179	188	195	200	205	210	215	220	225	230	230
115	106	110	115	121	127	134	143	152	162	173	184	193	200	205	210	215	220	225	230	235	235
116	107	111	116	122	129	137	146	155	166	177	187	195	201	206	211	216	221	226	231	236	236
117	108	112	118	124	132	140	149	159	170	181	191	200	207	212	217	222	227	232	237	242	242
118	108	113	119	126	134	142	152	162	174	186	196	205	213	220	225	230	235	240	245	250	250
119	109	114	121	128	136	145	155	166	178	189	199	208	216	223	228	233	238	243	248	253	253
120	110	116	123	130	138	148	158	170	182	193	203	212	220	227	232	237	242	247	252	257	257
121	111	117	124	132	141	151	162	174	187	198	208	217	225	232	237	242	247	252	257	262	262
122	111	118	125	134	143	154	165	178	190	201	211	220	228	235	240	245	250	255	260	265	265
123	112	119	127	136	146	157	169	182	194	205	215	224	232	239	244	249	254	259	264	269	269
124	113	120	129	138	148	160	172	185	197	208	218	227	235	242	247	252	257	262	267	272	272
125	114	121	130	140	151	163	176	189	201	212	222	231	239	246	251	256	261	266	271	276	276

Heat Index

Extreme Danger	Heat stroke likely.
Danger	Sunstroke, muscle cramps, and/or heat exhaustion likely. Heatstroke possible with prolonged exposure and/or physical activity.
Extreme Caution	Sunstroke, muscle cramps, and/or heat exhaustion possible with prolonged exposure and/or physical activity.
Caution	Fatigue possible with prolonged exposure and/or physical activity.

This chart is based upon shady, light wind conditions. Exposure to direct sunlight can increase the HI by up to 15°F. "+" indicates the heat index temperature is so great it is off the scale.

# SECTION VI: Appendices

---

## Appendix III: Chaperone and Emergency Contact Information

### Team Chaperones vs. Emergency Contacts

When competitors under the age of majority (minors) participate in a rally, there will be a designated "Official Team Chaperone." In the situation of scramble teams, the official team chaperone will be appointed by the rally officials and will be so noted in the rally program. The team chaperone serves as the team contact for rally and a responsible guiding presence to prepare the team for success. Competitors who are above the age of majority (adults) participating in a rally will not have a designated chaperone but must submit the name and contact information for their emergency contact.

### Team Chaperones

#### *Time Commitment*

The official team chaperone is responsible for team members during the hours of competition and on competition grounds only (from arrival on grounds until departing rally ground at beginning and end of each day of competition).

#### *Transportation, Driving and Lodging*

- Decisions to allow a competitor **that is a minor** to drive or not, who they can or cannot ride with, who they can or cannot have in a vehicle that they are driving, where they stay at night and with whom they stay, and who is to be responsible for a competitor are all decisions that must be made by the parent/legal guardian. These decisions are not a decision of USPC, their region, club/<sup>1</sup>center, or the rally organizer. Specific arrangements must be made by and between the parent/legal guardian and the adult assuming any of these responsibilities in the absence of the parent/guardian.

#### *Preparing Your Team for Success*

- Initiate contact with all team members prior to leaving for the competition and gather cell phone numbers as appropriate. In cases of scramble team members, request contact information from the rally secretary. Share this information with team captain and/or stable manager.
- Encourage the team to have meetings prior to leaving for rally. Be sure all members of a scramble team are included in the decision-making process, either by email or phone contact, if a distance away.
- Discuss team equipment, review all rules that apply and any decisions regarding snacks, drinks, plans for meals, etc. Determine how the team members plan to provide snacks and drinks (i.e., each team member contribute a sum of money to a pot or each member is assigned specific items to bring). If each is contributing money, it must be collected before the rally. Be sure to know who is bringing cooler(s), as

to avoid a trip to the local store.

- Plan arrival time at the competition site and any details such as arrangements for ordering bedding, if needed, and who is assigned to do this (again collect money in advance if needed).
- On the first day of the rally, gather the team together before they separate for the night and make plans for the next day. Include a review of their competition schedule and how they can best work together to help each other prepare.
- Determine a regular meeting place and de-brief the team at the end of each day of competition. Take this opportunity to offer words of praise, acknowledge their accomplishments, and encourage the sense of teamwork and team building. Guide the team towards constructive criticism and steer them away from finger pointing. Have the team make plans for the next day concerning time they will arrive on the competition grounds, who will feed mounts the next morning, who will re-supply the tack room cooler with ice, drinks and snacks (get requests for drinks/snacks) and make the plans for lunch. Be sure any plans for cooler and/or lunch delivery follow any requirements as stated in the competition entry and they understand the plan. Have the team leave with a plan for the next day in place before they go off for an evening of relaxation.

### Emergency Contacts

Anyone listed as an emergency contact for a competitor should be reachable by phone for the duration of the competition. Emergency contacts do not need to be on the competition grounds, but ideally are also within driving distance of the competition in the case of an emergency.



# SECTION VI: Appendices

## Appendix III: Chaperone Form

*To be completed by the chaperone and turned in with the rally entry for USPC members below the age of majority.*

### Chaperone duties shall include:

1. The primary function of the "Official Team Chaperone" is to ensure that there is a contact person for every USPC member below the age of majority, on the grounds for the duration of the competition.
2. While multiple Chaperone Forms may be turned in for a single team, only one person will be designated the Official Team Chaperone. If the Official Team Chaperone must leave the grounds during the competition, they must delegate the team chaperone duties to another responsible adult, making it clear that they are to respond to rally officials and any team members in your absence.
3. Be present and available to rally officials and all team members for the duration of the competition.
4. Being in contact with parents/guardians for all team members during competition hours.
5. Being in contact with all team members and their parents/ guardians outside of competition hours.
6. Have copy of and be familiar with the current discipline rulebook and the current Horse Management Handbook. Rulebooks available for download from [www.ponyclub.org](http://www.ponyclub.org).
7. Be aware that USPC members are required to wear a current, up to date USPC medical card/bracelet on their arm at all USPC activities.
8. Be familiar with the effects of heat and humidity and the potential risk for heat related illness. Take an active role in helping to keep all team members well hydrated and take every opportunity to encourage water breaks.
9. Uphold USPC Substances and Weapons Policy which prohibits the inappropriate or illegal use of any substance, including but not limited to drugs or alcohol, by anyone participating in any manner. Weapons of any kind are forbidden. Refer to About/About the Organization/By-Laws, Policies and Resolutions on [www.ponyclub.org](http://www.ponyclub.org) for the full policy statement.
10. Remember that administration of medications is the sole responsibility of the parent/guardian.

I have read and understand the duties of a chaperone as listed above.

Chaperone for the following team or individual(s)

-----  
-----  
-----

Name of Chaperone: \_\_\_\_\_

Signature: \_\_\_\_\_

Cell Phone Number: \_\_\_\_\_

Date: \_\_\_\_\_

# SECTION VI: Appendices

---

## Appendix III: Emergency Contact Form

*for USPC Members Above the Age of Majority*

The age of majority is the threshold of adulthood in law. As USPC members above the age of majority are adults in the eyes of the law and therefore responsible for themselves; USPC does not require a "chaperone" for these members at competitions. USPC does require that members above the age of majority submit Emergency Contact information for each competition. Age of majority varies per state.

USPC Member: \_\_\_\_\_ Current Age: \_\_\_\_\_ State of Residence: \_\_\_\_\_

Competition Name: \_\_\_\_\_ Competition Date: \_\_\_\_\_

Emergency Contact Name: \_\_\_\_\_

Emergency Contact Relationship to Competitor: \_\_\_\_\_

Emergency Contact Home Phone Number: \_\_\_\_\_

Emergency Contact Cell Phone Number: \_\_\_\_\_

*An additional Emergency Contact can be included, but is not required.*

Secondary Emergency Contact Name: \_\_\_\_\_

Secondary Emergency Contact Relationship to Competitor: \_\_\_\_\_

Secondary Emergency Contact Home Phone Number: \_\_\_\_\_

Secondary Emergency Contact Cell Phone Number: \_\_\_\_\_

# Section VI: Appendices

## Appendix IV: Junior/Senior Team Formation

### PERMISSION FOR JUNIOR COMPETITORS TO PARTICIPATE IN A RALLY ON A TEAM WITH SENIOR COMPETITORS

When merging a member under the age of 18 on a team with member(s) 18 years of age or older, written permission should be obtained by the person configuring the team. This form can be used for written permission, but other methods (email, etc.) are also acceptable. Written permission should be maintained with the rally entry paperwork.

This agreement acknowledges that \_\_\_\_\_ and their parent(s)/legal guardian(s) agree to the participant's placement onto a rally team with:

\_\_\_\_\_  
(Name of Senior Participant)

\_\_\_\_\_  
(Name of Senior Participant)

\_\_\_\_\_  
(Name of Senior Participant)

\_\_\_\_\_  
(Name of Senior Participant)

at \_\_\_\_\_ rally.  
(name of rally)

PARTICIPANT NAME (Print): \_\_\_\_\_

DATE OF BIRTH: \_\_\_\_\_

PARTICIPANT SIGNATURE: \_\_\_\_\_

DATE: \_\_\_\_\_

PARENT/GUARDIAN NAME (Print): \_\_\_\_\_

PARENT/GUARDIAN SIGNATURE: \_\_\_\_\_

DATE: \_\_\_\_\_

\*PARENT/GUARDIAN NAME (Print): \_\_\_\_\_

\*PARENT/GUARDIAN SIGNATURE: \_\_\_\_\_

DATE: \_\_\_\_\_

Note: Combining junior and senior teams into one division is not the same as combining junior and senior members onto one team. Junior competitors can always compete up a division as a senior to fill out a team. Senior competitors can never compete down to a junior division. Before combining junior and senior aged competitors on the same team, rally organizers must obtain the permission of the junior competitor and their parent(s)/legal guardian(s).

\*Second parent/guardian signature if applicable.

# SECTION VI: Appendices

## Appendix V: USPC Gymkhana Rally TD's Report

(This form is also available electronically on the rulebooks page of the USPC website.)

\*=information required; circle yes or no when you see **(yes/no)**.

TD/Steward's Name \* \_\_\_\_\_ Phone \* \_\_\_\_\_

TD/Steward's Email Address \* \_\_\_\_\_

TD/Steward's License number and affiliation \_\_\_\_\_

Organizer's Name \* \_\_\_\_\_ Phone \* \_\_\_\_\_

Organizer's Email Address \* \_\_\_\_\_

CHMJ Name\* \_\_\_\_\_ Phone \* \_\_\_\_\_

CHMJ Email Address \* \_\_\_\_\_ Number of AHMJ's\* \_\_\_\_\_

### Rally Information

Region \* \_\_\_\_\_ Rally Start Date \* \_\_\_\_\_ Rally End Date \*

Rally locations (please include all if multiple) \_\_\_\_\_

Is this a standard rally? \* \_\_\_\_\_

Did you have a CURRENT copy of the discipline rulebook? \* **(yes/no)**

Did you read the rulebook prior to attending the rally? \* **(yes/no)**

Was the entire rally conducted according to these rules? \* **(yes/no)**

Did horse management function according to the rules? \* **(yes/no)**

Did you have any problem with a stated rule? \* **(yes/no)** If yes, please tell us why. \_\_\_\_\_

Did you have a situation for which there was not a stated rule? \* **(yes/no)** If yes, please describe the situation. \_\_\_\_\_

Did any competitors receive Yellow Cards given during the rally? **(yes/no)** If yes, how many and why. \_\_\_\_\_

Were any competitors disqualified during the rally? \* **(yes/no)** If so, please tell us who and why. \_\_\_\_\_

# SECTION VI: Appendices

---

Was the rally well-organized? **(yes/no)** Please describe. \_\_\_\_\_  
\_\_\_\_\_  
\_\_\_\_\_

Were the facilities suitable for all phases of the rally? **(yes/no)** If no, please describe areas of concern. \_\_\_\_\_  
\_\_\_\_\_  
\_\_\_\_\_

Were the organizers and other officials friendly and supportive to competitors and each other? \* **(yes/no)**

Was sufficient personnel provided to manage all phases? \* **(yes/no)**

Were medical personnel & equipment (EMT, ambulance) on the grounds during mounted activities and on call at all times? \* **(yes/no)**

Were any accident reports filed? \* **(yes/no)**

For the duration of the rally, was safety placed as a priority? **(yes/no)** Please describe. \_\_\_\_\_  
\_\_\_\_\_  
\_\_\_\_\_

Were the communications suitable for all phases of the rally? **(yes/no)** If no, please describe areas of concern. \_\_\_\_\_  
\_\_\_\_\_  
\_\_\_\_\_

Were briefings held? **(yes/no)** Please describe. \_\_\_\_\_  
\_\_\_\_\_  
\_\_\_\_\_

Was the rally a learning experience for all competitors? \* **(yes/no)** Please describe. \_\_\_\_\_  
\_\_\_\_\_  
\_\_\_\_\_

Do you feel you were given all the materials to do your job effectively? \* **(yes/no)** If no, please describe why not. \_\_\_\_\_  
\_\_\_\_\_  
\_\_\_\_\_

## Horse Management Review

As the TD/steward, you are charged with the first level of reviewing the decisions in Horse Management. Under the rules of competition, the initial protest from the decision of the CHMJ is to the TD/steward. A protest can only be made by the team or individual competitor against whom an adverse decision is made. Therefore if a protest comes to you to reconsider the decision of the CHMJ and you do NOT sustain the decision of the judge, the protest is concluded. If you do sustain the CHMJ, then a protest can be placed before the discipline ground jury.

Were all inquiries/protests that were brought to you as TD/steward in written form on the official form?\* **(yes/no)**

Do you have any comments on the Horse Management competition at this rally? \_\_\_\_\_  
\_\_\_\_\_  
\_\_\_\_\_

Do you have any additional comments or thought you would like to share? \_\_\_\_\_  
\_\_\_\_\_

# SECTION VI: Appendices

---

## Rally Competitor Numbers

Please utilize the lines below to indicate what competition divisions were offered and the number of teams and competitors in each.

	Level/ Division*	Number of Teams*	Number of Competitors*	Number of Competitors with D-2 Certification above 10 years of age*	Number of Competitors with C-1 Certification above 12 years of age*
Junior Walk/Trot	_____	_____	_____	_____	_____
Senior Walk/Trot	_____	_____	_____	_____	_____
Junior Novice	_____	_____	_____	_____	_____
Senior Novice	_____	_____	_____	_____	_____
Junior Intermediate	_____	_____	_____	_____	_____
Senior Intermediate	_____	_____	_____	_____	_____
Junior Advanced	_____	_____	_____	_____	_____
Senior Advanced	_____	_____	_____	_____	_____
Other (please specify)	_____	_____	_____	_____	_____

President of the Ground Jury's Name \* \_\_\_\_\_ Phone \* \_\_\_\_\_

President of the Ground Jury's Email Address \* \_\_\_\_\_

President of the Ground Jury's License number and affiliation \_\_\_\_\_

Please email to [events@ponyclub.org](mailto:events@ponyclub.org) or mail to  
 Activities Department • United States Pony Clubs • 4041 Iron Works Parkway • Lexington, KY 40511  
 859.254.7669 • Fax 859.223.4652 • [www.ponyclub.org](http://www.ponyclub.org)

# SECTION VI: Appendices

## Appendix VI: Gymkhana Coaching Guidelines Form

*Each coach should have a copy and a signed copy submitted with entries. Photocopy as necessary.*

Penalties for violating these coaching guidelines will be assessed by the discipline ground jury and/or overall ground jury under the rules governing unauthorized assistance. Any coach not adhering to the rules set forth below may be removed from their position for the duration of the phase and/or competition.

Coaches are recommended for Gymkhana rallies and Championships. There may be one or more coaches per team; the organizer or ring steward may limit the number of coaches in a warm-up area at any given time.

### Agreement

By signing this form, you:

- Agree to be familiar with and observe all USPC By-Laws, Policies and competition rules.
- Agree to be governed by Horse management guidelines as expected of competitors, including appropriate attire, footwear and conduct.
- Agree to adhere to the USPC Conflict of Interest and Code of Ethics Policies in all your actions and decisions.
- Agree to conduct yourself in a fair and courteous manner.

### Coaches Must

- Check in as requested and attend any official coaches' briefings.
- Be familiar with, understand and comply with the current USPC discipline and Horse management rules.
- Be aware of the welfare of mount and rider.
- Wear identification as provided by the organizer/secretary during the competition times.
- Follow all discipline coach parameters outlined in the discipline rulebook.
- Assist competitors in learning and understanding all rules pertinent to the competition.
- Help any Pony Club competitor who asks for help or who is present without a coach.

### All phase coaches must sign that they have read this sheet:

I \_\_\_\_\_ have read and agree to follow the USPC Gymkhana Rulebook and above guidelines for coaching.

Printed Name: \_\_\_\_\_ Signature: \_\_\_\_\_

Date: \_\_\_\_\_ Cell Phone: \_\_\_\_\_ Email: \_\_\_\_\_

Please list the competitors/teams you are coaching:

1. \_\_\_\_\_
2. \_\_\_\_\_
3. \_\_\_\_\_
3. \_\_\_\_\_
4. \_\_\_\_\_
4. \_\_\_\_\_
5. \_\_\_\_\_
6. \_\_\_\_\_

### Coaches Must Not

- Enter the barn except during authorized visiting times.
- Interfere with the immediate care of the mount under penalty of elimination of the competitor.
- Coach in a manner that interferes with the warm-up of other competitors.
- Be the organizer, and member of the organizing committee or any other official of the competition.
- Be a team chaperone.
- Be a RS at a regional competition.

### Coaching Duties

- Warming-up competitors for competition in the designated warm-up areas only.
- In addition, a coach may lead a competitor's mount into the arena area.
- Coaches may observe but not participate in (unless requested), soundness checks or mount inspections.
- Meet with the team to discuss ride times, planning and how to best utilize the coach within the team.

### Communications between Coaches and Competitors

- Coaches may communicate with the competitors during the official briefing and any subsequent briefings as required by the organizer and in the warm-up area prior to and following the competitor's ride.
- Coaches may accompany competitors during their ride, arena inspection, course walks or any other subsequent times competition areas are open for warm-up, during which they may give advice and coach.

### Competitors who wish to Coach while Competing

Championships competitors who are 18 years of age as of January 1 of the competition year may coach other members recognizing that:

- No scheduling changes will be made to accommodate coaching /riding times.
- Care of mount and other competitor responsibilities take precedence over coaching.

# SECTION VI: Appendices

---

## Appendix VII: Gymkhana Yellow (Warning) Card

UNITED STATES PONY CLUBS

A yellow warning card may be issued by a rally official at a USPC competition to any competitor, spectator or participant for improper conduct, or for noncompliance with the rules. If the offence is considered egregious, the discipline ground jury may decide to assess penalty points to accompany the Yellow Card as outlined in Article 21 and 53.

Important information to know about the issuance of a Warning (Yellow) Card:

1. A Yellow Card is a warning with possible attached penalty points given for any infraction that is a disqualifiable offense.
1. A Yellow Card may be, but is not required to be given before the disqualification of a competitor or team.
1. A Yellow Card that incurs penalty points that will be recorded in the "Other" column of the scoresheet.
1. There is no appeal against receiving a Yellow Card.
1. A copy of any Yellow Card issued must be sent to the Activities Department, [events@ponyclub.org](mailto:events@ponyclub.org).

Issued to: (Name) \_\_\_\_\_ Competitor # \_\_\_\_\_

Region/Club/Center: \_\_\_\_\_

Address: \_\_\_\_\_

City/State/Zip: \_\_\_\_\_

At the following competition: \_\_\_\_\_

Date/Time of incident: \_\_\_\_\_

Description of incident: \_\_\_\_\_

\_\_\_\_\_

\_\_\_\_\_

\_\_\_\_\_

\_\_\_\_\_

\_\_\_\_\_

\_\_\_\_\_

\_\_\_\_\_

\_\_\_\_\_

*(please use back of page if necessary)*

Issuing Official: (print) \_\_\_\_\_ Position: \_\_\_\_\_

Signature: \_\_\_\_\_ Date: \_\_\_\_\_

Phone: \_\_\_\_\_ Email: \_\_\_\_\_

Please email to [events@ponyclub.org](mailto:events@ponyclub.org) or mail to  
Activities Department • United States Pony Clubs • 4041 Iron Works Parkway • Lexington, KY 40511  
859.254.7669 • Fax 859.223.4652 • [www.ponyclub.org](http://www.ponyclub.org)